

E-Catalog 2019

Solutions by Eich

06 / 2019



eich

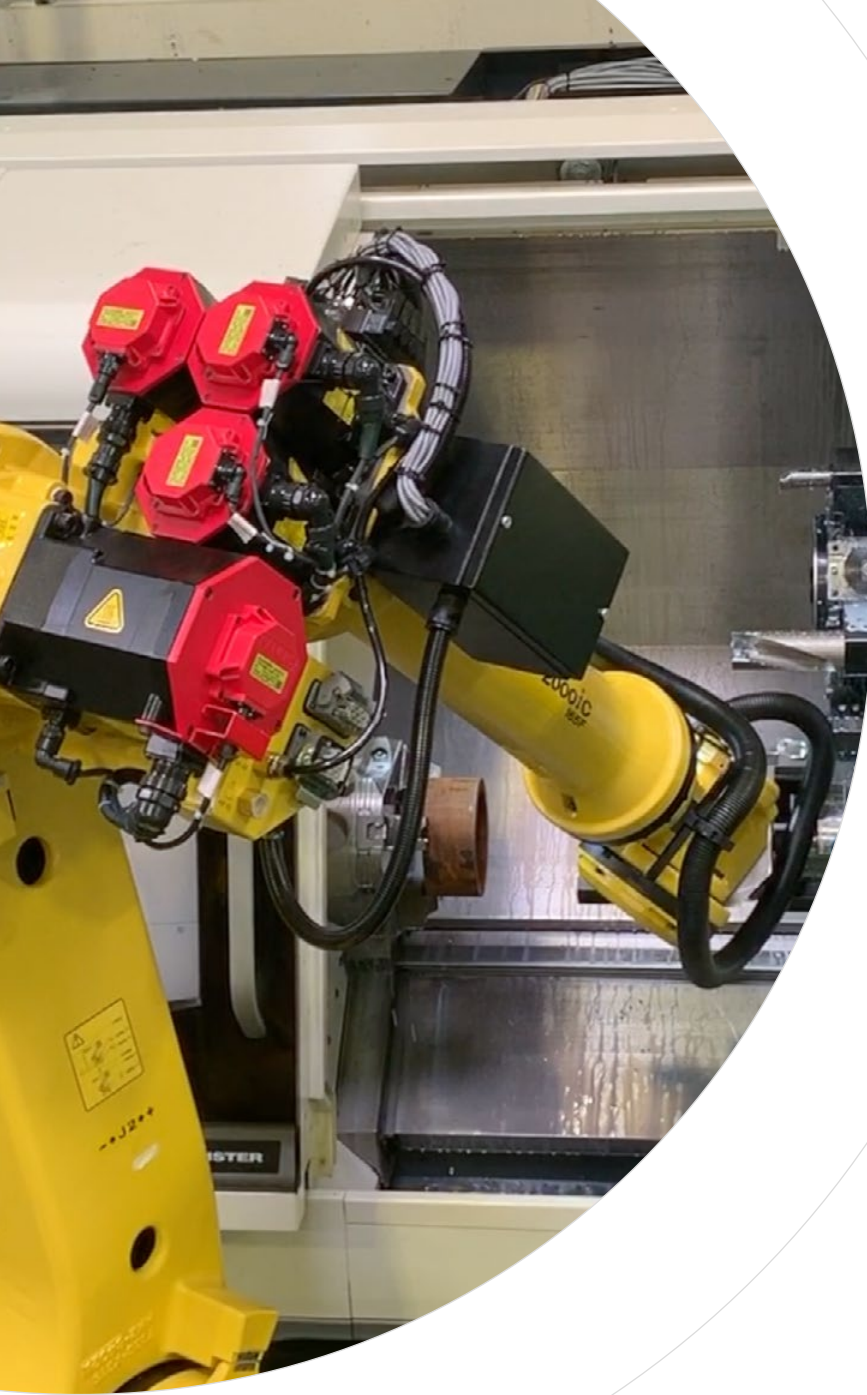

Individual request –
individual solutions.

Content

The Company

Production and technology

Know How

Philosophy

History

Success

Products

Types

Spring bush bearings

Modular System

Spare Parts

Split bearings

SACRB

Cylindrical roller bearings

full complement

with cage

Supporting rolls

Material

Hardening process

Applications

Continuous casting

Furnace bearings

Rolling mills

Waste Incinerators

Service

Check and repair

Spare parts

The Company



- › Production and technology
- › Know How
- › Philosophy
- › History
- › Success

The Company

Production and technology

Beginning with the problem formulation and application description, EICH develops and produces rolling bearings with a particularly high degree of customization. This finds its continuation in the production, where lot sizes from one piece require highest flexibility.

Depending on customer requirements and / or application, the bearings can alternatively be manufactured from high-strength, high-temperature or stainless steel grades. As standard material, the common rolling bearing steels are processed.

The production range of rolling bearings starts at an internal diameter of 30 mm and ends at 1800 mm outside diameter. A very high degree of vertical integration - from development to final acceptance, all processes take place on-site. CAD design, machining of workpieces on modern CNC machines, soft / hard machining and heat treatment are seamlessly used by EICH each other and are subject to constant quality controls.

That is the basis for special bearings with short delivery times, optimal production quality and fair market prices.



The Company

Know How

In close cooperation with our customers, we develop and produce rolling bearings with a high degree of customization; exactly matched to the respective application requirements.

Eich's self-concept is to act as a technological development partner of the industry. From the very beginning, starting in the planning and development stage of plants, aggregates and applications, we introduce our knowledge and experience. Eich also remains a competent partner for later optimization. The close cooperation with the customers is the basis for a rolling bearing development that meets the individual requirements.

As a member of the FVA (Forschungsvereinigung Antriebstechnik) we are embedded in the rolling bearing working group we keep in close contact with the innovations of the industry and are involved in the supervision of research projects. We cooperate with research institutes in well-known universities.



The Company

Philosophy

Simple principles of bearing technology translate into high quality and customized solutions for our customers that is our philosophy. The principle of simplicity is reflected in all areas of the company and contributes to transparency.

In production, highly qualified skilled workers contribute to this principle. Our location in Germany offers the opportunity to ensure this continuously. Concentrated on the requirements of the customers, the production areas are focused on absolute flexibility and work on continuous improvement of production processes. Through years of experience, the employees know what is important and contribute with their ideas to product-specific improvements.



The Company

History

In the beginning of the 20th century our area was a melting pot for coal mining and there was a major steel work on-site.

At the time, 15 employees did pioneering work in the development and production of the type of bearing, a new kind in Germany: the spring roller bearing. Completely new was the development of the inner and outer rings of these bearing types: spring inner and spring outer bush. The company soon established as a highly specialized provider - and continued to focus its orientation in the 1940s and 1950s on the growing steel and heavy industry.

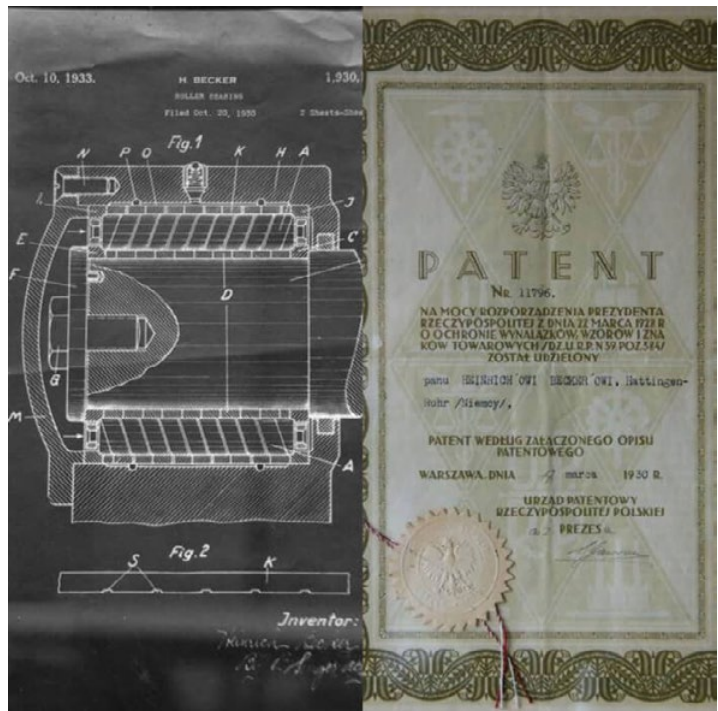

Maschinenfabrik Joseph Eich, vorm. Becker & Co., GmbH, Hattings (Rolle) - Speziallager, Federrollenlager, Rollenlager, Fabrikation für folgende Verwendungszwecke: Walzenherstellung, Warmströme, Konverter, Elektrodrain, Transportgeräte, Bagge, Textilmaschinen, Strahlmaschinen

Today the Eich Rollenlager GmbH is worldwide well known as expert for and manufacturer of spring roller bearings, roller bearings and special solutions.



The Company

Success

From the founding days until the 1980s Eich was established as specialist for special bearing problems and their solution. In the beginning 1980s the internationalization starts through first deliveries to France and India. Besides the fact of being a supplier to OEMs the Eich bearings began their trip around the world. The crises of the bearing industry in the 1990s led to major changes at Eich. We have met these requirements through changes in production processes, an expanded product portfolio and improved organization. The positive development of the last decades have confirmed these entrepreneurial decisions.

The base for our success relies on three towers of strength: Closest cooperation with the most important plant manufacturers for continuous casting machines, this tradition lasts for decades meanwhile and is still ongoing.

The continuous and closed communication with highly experienced plant operators in Germany and international. This led in particular to plant-specific improvements and new developments.

The employees of the company who take customer's requirement as a whole and intensively support the delivery of a product through comprehensive services. Innovation and creativity are our daily companions. As an example: our employees innovate, designed and built special machinery for two production areas - spring bush production and external grinding – so we were and are able to increase flexibility, increase productivity and quality, including the increase of work-safety.

Products



- › Spring bush bearing
- › Split bearings
- › SACRB
- › Cylindrical roller bearings
- › Hardening process

Products

Spring bush bearings

Spring bush bearings, spring roller bearings

These special rolling bearing designs build the brand essence of Eich. They are manufactured since the founding days of Eich. Initially, some of these bearing types had been used in various mining applications. An example is the yoke type roller „Alaf“, a type of wheel bearing for transport containers for discharging coal. The good experience in mining applications provided important insights into the performance of these bearing also for other applications. One example is the steel industry with different applications, roller table rollers in rolling mills, support and guide rollers in continuous casting, roller table rollers in furnaces or in finishing equipment.

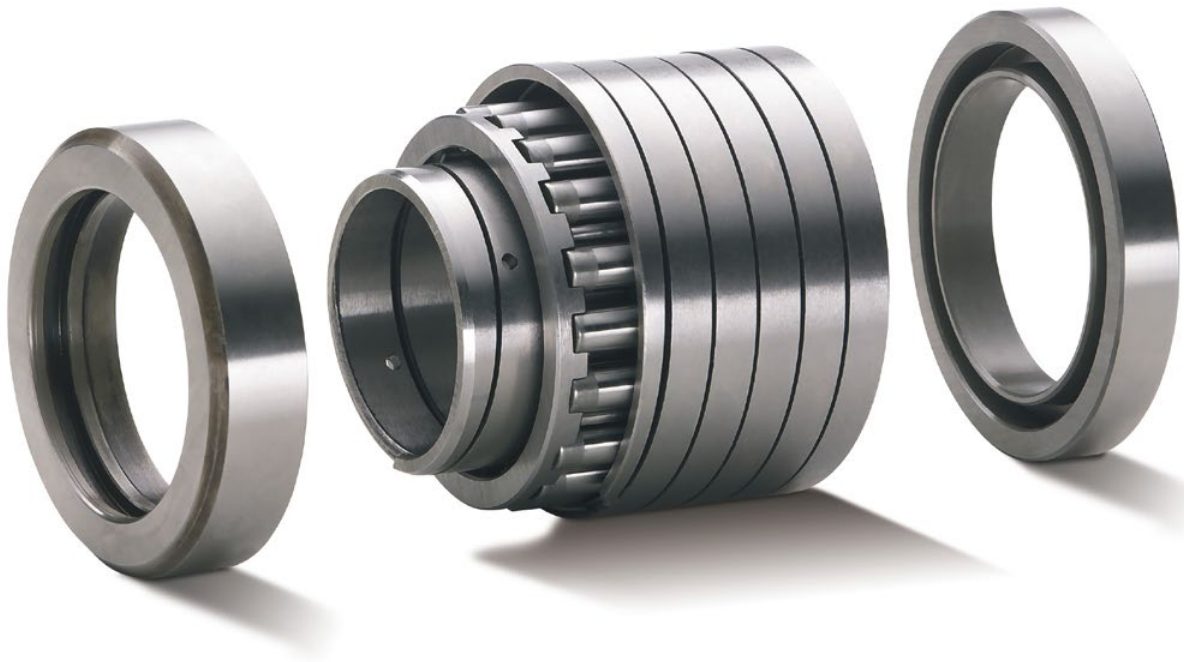

Products

Spring bush bearings

Floating bearing

Bearing type	Spring- inner- bushing	Spring- outer- sleeve	Spring- roller- cage	Solid- roller- cage	Solid- inner- bushing	Solid- outer- sleeve
EL		●	●			
ELMA			●			●
ELR		●		●		
ELMAR				●		●
B	●	●	●			
BMA	●		●			●
BMI		●	●		●	
BMF			●		●	●
BR	●	●		●		
BMAR	●			●		●
BMIR		●		●	●	
BMR				●	●	●
ABC	●	●		●		

Products

Spring sleeve bearings

Locating bearing

Bearing type	Spring- inner- bush	Spring- outer- bush	Spring- roller- cage	Solid- roller- cage	Solid- inner- bush	Solid- outer- bush	Rings
UL	●	●	●				●
ULMA			●			●	●
ULMI		●	●		●		●
ULMF			●		●	●	●
ULR	●	●	●	●			●
ULMAR	●			●		●	●
ULMIR		●		●	●		●
ULMR				●	●	●	●

Products

Spring bush bearings

ABC roller bearings

Type of product	Product No.	Product dimension	Weight [kg]	C0 [kN]	C [kN]
abc	10456e	45/80 mm x 80/70 mm	2,1	327	205
abc	11588e	50/80 mm x 75/70 mm	1,6	332	189
abc	10455e	50/85 mm x 80/70 mm	2,2	375	220
abc	8227e	50/95 mm x 85/50 mm	2	320	205
abc	7565e	50/95 mm x 85/50 mm	3	320	205
abc	11166e	55/85 mm x 75/70 mm	1,8	380	215
abc	11167e	60/95 mm x 75/70 mm	2,4	432	230
abc	10203e	60/89 mm x 73/63 mm	1,6	400	195
abc	8545e	65/105 mm x 90/64 mm	2,2	390	245
abc	11590e	65/95 mm x 75/70 mm	2	410	208
abc	11259e	75/105 mm 75/70 mm	2,7	520	255
abc	10227e	75/104 mm x 73/63 mm	1,9	440	203
abc	10236e	80/120 mm x 73/63 mm	3	530	265
abc	8546e	85/125 mm x 90/64 mm	2,7	530	295
abc	10389e	90/121 mm x 73/63 mm	2,4	528	247

Products

Spring bush bearings

BR roller bearing

Type of product	Product No.	Product dimension	Weight [kg]	C0 [kN]	C [kN]
br	8132e	35/60 mm x 64/38 mm	0,6	115	82
br	2671e	35/62 mm x 50/36 mm	0,6	90	65
br	2436e	35/65 mm x 56,5/38 mm	0,65	95	50
br	2955e	35/65 mm x 64/38 mm	0,7	100	85
br	11386e	40/68 mm x 58/45 mm	0,9	160	101
br	10144e	40/71 mm x 60/45 mm	0,9	145	110
br	10772e	45/67 mm x 50/40 mm	0,6	130	80
br	10063e	45/67 mm x 73/63 mm	0,8	240	130
br	10145e	45/75 mm x 86/70 mm	1,3	260	175
br	10541e	50/80 mm x 75/70 mm	1,5	350	215
br	11941e	50/85 mm x 57/45 mm	1,4	153	108
br	8679e	50/85 mm x 73/45 mm	1,5	183	140
br	3110e	50/95 mm x 95/70 mm	2,1	285	215
br	11181e	55/80 mm x 73/63 mm	1,2	275	140
br	6204e	55/90 mm x 73/63 mm	2	320	185
br	8466e	60/89 mm x 73/63 mm	1,6	365	175
br	8065e	60/89 mm x 73/63 mm	1,6	345	160
br	6205e	60/95 mm x 73/63 mm	2	365	200

Products

Spring bush bearings

BR roller bearing

Type of product	Product No.	Product dimension	Weight [kg]	C0 [kN]	C [kN]
br	5522e	60/110 mm x 105/94 mm	3,4	515	340
br	9138e	62/89 mm x 73/63 mm	1,5	350	190
br	8511e	70/99 mm x 73/63 mm	1,7	390	180
br	2675e	70/120 mm x 71,5/50 mm	3	315	205
br	11189e	75/104 mm x 73/63 mm	1,8	393	188
br	11397e	75/105 mm x 73/63 mm	3	431	200
br	11190e	90/121 mm x 73/63 mm	2,4	538	250

YOU NEED AN INDIVIDUAL DIMENSION?

Then feel free to contact us. We offer all bearing designs in individual dimensions as well as specifications for the respective application.

>> CONTACT US <<

Products

Split bearings

Split bearings are adapted designs to specific applications, such as cranked drive shafts (driven strand guide rollers, support bearings for long / heavy drive spindles), very long drive shafts (shafts, drive shafts in cooling beds) or bearings locations where mounting and dismounting of non-split bearings is not possible (drive shaft of a heavy fan). Split rolling bearings are available as floating bearings, locating bearings and guiding bearings. Locating bearings and guiding bearings carrying radial as well as axial forces. Thrust bearings are also available as split designs, for example as a support bearing for heavy vertical shafts. The split bearings correspond in principle to the structure of non-split bearings, Inner ring, set of rolling elements (full complement or with cage) and the outer ring. All parts except the rolling elements are split. To fit the inner ring of a split bearing so-called clamping rings are added. The inner rings include a pap between their halves, usually between 0.3 to 0.5 mm. With this feature a strong and safe fit for the inner ring is ensured. The gap has a certain angle against the rolling direction to avoid negative effects under load.

The outer ring has no gap and is held by the housing bore. Another design is the so-called split housing bearing unit, this unit includes, in addition to the split bearing, a split housing. These housings available with different features, e.g. integrated water cooling. It should be mentioned that the housing usually shows a minor wearing and thus can be used multiple times.

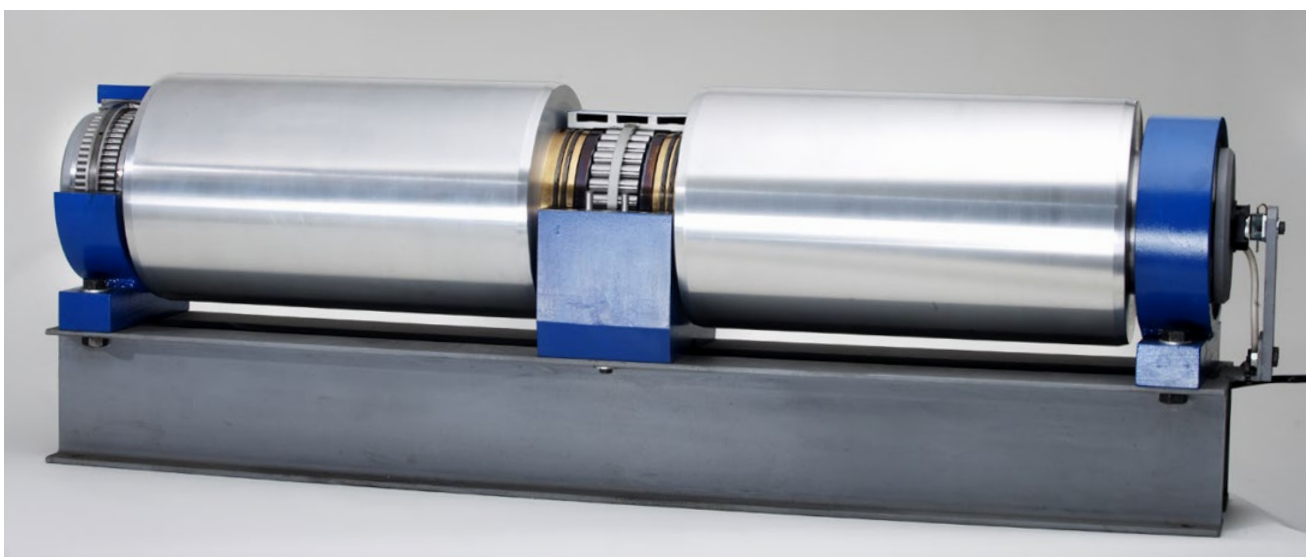

Products

Split bearings



Split continuous casting bearing units



Spindle bearings for use in the hot rolling mill



Split Ball bearing for use in a Waste incinerator

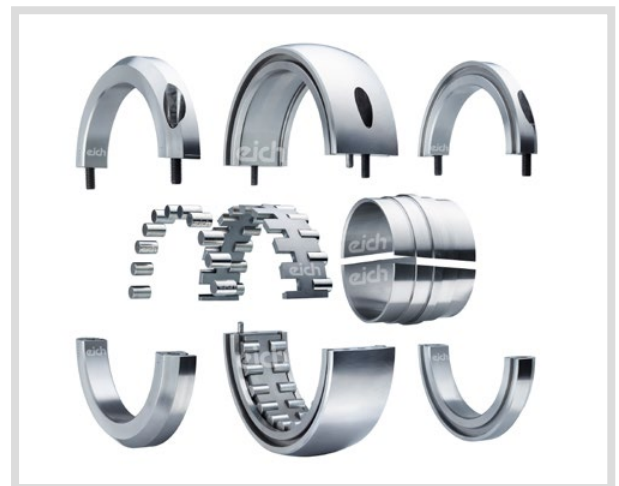

Application Cooling Bed

Products

Split bearings

SLEGET bearing

Product type	Product No.	Product dimension	Weight [kg]	Shaft-Ø [mm]	Roller-Ø [mm]	Window -width [mm]	C0 [kN]	C [kN]
sleget	11636e	145/120 mm x 120/185 mm	18	75	150	140	710	320
sleget	10540e	175/120 mm x 150/227,5 mm	25	95	175	130	820	360
sleget	6354e	212/134 mm x 145/235 mm	38	100	200	146	810	435
sleget	6772e	212/148 mm x 145/237,5 mm	39	105	205	165	1040	520
sleget	8189e	220/145 mm x 160/260 mm	41	120	220	165	745	375
sleget	8865e	250/162 mm x 165/280 mm	60	130	250	180	1580	800
sleget	8832e	250/160 mm x 160/275 mm	55	135	250	184	1255	645
sleget	8191e	260/165 mm x 185/305 mm	55	140	260	185	1352	677
sleget	7406e	310/174 mm x 200/340 mm	94	160	310	190	1872	1037

Products

SACRB

The SACRB bearing is a rolling bearing that combines highest static load capacities and significant capability of aligning. The name of this bearing type describes the function, it is an adjustable roller bearing. This type of bearing consists of an inner ring, the set of rolling elements, usually full complement or in a few cases with a cage, a spherical outer ring and the adjusting ring, the calotte. The spherical outer ring fits in the calotte and compensates misalignment of the bearing. The aligning movement thereby does not occur in the rolling contact. The load bearing capacity of the roller bearing remains in every position. The floating bearing has a cylindrical and straight inner ring, the rolling elements can easily float axially. By the principle of angle adjustment described above, even in the tilted state, an unconstrained axial displacement, e.g. by thermal expansion, is possible. The locating bearing has either a fixed rib on the inner ring and a lateral thrust ring, or a straight cylindrical inner ring and two lateral thrust rings which take the axial loads.

The SACRB bearings are an alternative to spherical roller bearings or toroidal bearings, they can be exchanged usually 1: 1.

DOWNLOADS

By clicking on the respective PDF you can open it for viewing and download it as needed.



Products

SACRB

SACRB bearing

Product type	Product No.	Product dimension	C0 [kN]	C [kN]
sacrb	7896e	50/110 mm x 40 mm	288	178
sacrb	8931e	55/120 mm x 43 mm	360	230
sacrb	10579e	65/100 mm x 35 mm	250	117
sacrb	7897e	65/140 mm x 48 mm	473	240
sacrb	8504e	75/125 mm x 40 mm	365	195
sacrb	8082e	80/140 mm x 33 mm	335	180
sacrb	11595e	80/140 mm x 43/33 mm	345	175
sacrb	10248e	90/125 mm x 46 mm	455	175
sacrb	11219e	90/135 mm x 60/55 mm	605	245
sacrb	8195e	100/150 mm x 50 mm	630	241
sacrb	8362e	100/150 mm x 76 mm	615	270
sacrb	10319e	100/165 mm x 62/52 mm	660	295
sacrb	11570e	100/165 mm x 65 mm	790	335
sacrb	10672e	100/215 mm x 73 mm	1000	570
sacrb	8072e	110/170 mm x 60 mm	859	350
sacrb	8326e	110/170 mm x 76 mm	750	315
sacrb	10036e	110/180 mm x 69 mm	1000	400
sacrb	11569e	120/180 mm x 60 mm	920	365

Products

SACRB

SACRB bearing

Product type	Product No.	Product dimension	C0 [kN]	C [kN]
sacrb	8412e	120/180 mm x 60/87 mm	825	325
sacrb	8004e	130/200 mm x 69 mm	1150	410
sacrb	8921e	130/210 mm x 80 mm	1285	585
sacrb	11416e	140/195 mm x 50/40 mm	595	255
sacrb	8442e	140/225 mm x 68 mm	1055	530
sacrb	7777e	150/225 mm x 75 mm	1400	460
sacrb	8133e	160/240 mm x 80 mm	1600	575
sacrb	8268e	170/260 mm x 90 mm	1995	745
sacrb	10519e	180/280 mm x 100 mm	2020	1020
sacrb	10212e	196/320 mm x 140 mm	3340	1400
sacrb	9033e	200/310 mm x 82 mm	1890	800
sacrb	8419e	220/340 mm x 90 mm	2445	984
sacrb	8574e	240/400 mm x 128 mm	3650	1750

YOU NEED AN INDIVIDUAL DIMENSION?

Then feel free to contact us. We offer all bearing designs in individual dimensions as well as specifications for the respective application.

>> CONTACT US <<

Products

Cylindrical roller bearings

Cylindrical roller bearings with high load capacity

What are the advantages of such roller bearings?. Due to their design, they have a high load-bearing capacity. The large radial load rating of such a bearing makes it particularly powerful, especially at high loads. Spherical roller bearings have a lower load capacity due to their smaller line contact while the outer dimensions are the same. Cylindrical roller bearings have a longer line contact on their larger surface despite their small size. If required, the cylindrical roller bearings manufactured Eich Roller Bearings can be made of heat-resistant material.

Cylindrical roller bearings can be used as floating or locating bearing. The fields of application for cylindrical roller bearings made by Eich Roller Bearings are manifold. Various bearings used in almost all areas of mechanical and plant engineering and support users especially in dealing with large and complex machines and plants.



Products

Cylindrical roller bearings

Roller bearings with longer rolling elements

Are there any methods to optimize bearing capacities while keeping the cross section? Cylindrical roller bearings have the advantage that they are designed for this. Every bearing is designed for an optimum load carrying capacity. Through our independent production we have always the option to use special rolling elements, beyond the standard sizes from DIN ISO. Despite a compact cross section of the bearing, the needle-like rolling elements can generate an optimum static load capacity by their length and number. The rolling elements are long cylindrical rollers. Due to the design, Cylindrical Roller Bearings can be installed especially if there is little space, but a high load rating has to be achieved. Therefore, such bearings are often installed in facilities of the heavy industry, but there is a variety of other applications.

Different bearing solutions can be realized such as single-row or multi-row bearings, depending on the needs from the application.



Products

Cylindrical roller bearings

Roller bearings with long life

How long can a roller bearing be used? Depending on the application, the materials for these roller bearings are precisely compiled to adapt the cylindrical roller bearing to your requirements. Therefore it is of major importance to get all available application details, e.g. the expected temperatures, loads and speed. Based on this, a problem solution must also be found for seals. The Eich Roller Bearings are also characterized by their high dirt and temperature insensitivity. In conjunction with the high quality materials and modular design for most bearings, a long service life can be expected. We at Eich Rollenlager see ourselves as problem solvers. Even under the harshest conditions, the bearing units must work properly and perform reliable. Where other bearings reach their limits, our cylindrical roller bearings are used! Especially for special cases we find a solution in close consultation with you and adapt our bearings to your requirements. Our roller bearings are not standardized or common because we do not manufacture bearings in series. Our goal is to find special solutions where standard bearings fail.

PERSONAL ADVICE

Do you want to get advice for your project or do you have a problem with various bearings?

Do not hesitate to contact us and we will find an alternative solution for your problem, no matter whether it is a cylindrical roller bearing or a needle roller bearing. Our bearings are very dirt and heat resistant and can meet your demands.

>> CONTACT US <<

DOWNLOADS

By clicking on the respective button you can open PDFs for viewing and download as needed.

Products

Hardening process

Materials and heat treatment at Eich roller bearings

Materials and heat treatment are important components and processes that influence the properties and performance of rolling bearings. In recent years, we have significantly expanded our expenses in this area. In the past materials purchase and heat treatment was based on standards. Today our process starts with skilled and qualified material selection, the heat treatment process is an integral part of the design process right from the beginning of the design process of our products.

In close cooperation with our material suppliers and hardening shops, we plan and simulate today the best material selection and the most suitable heat treatment process for the respective applications.

In addition, we work with scientific research institutes such as the Science institute of VDEh, and universities.

Products

Hardening process

Materials for rolling bearings and rolling bearing parts

There are a number of materials available for the different types and applications of rolling bearings, each of which is selected by weighing several criteria. First and foremost is the performance of the rolling bearing, but also issues of economy, environment protection, availability and processability influence the choice of materials.

The best-known and probably the most widely studied steel in the world is the 100Cr6. Since the turn of the century from the 19th to the 20th century and the work of Stribeck, this steel grade, with about 1% carbon and 1.5% chromium, is almost unchanged in its chemical composition.

The steel qualities commonly used today for rolling bearings are listed in the international standard DIN EN ISO 683-17 and described in detail.

Tabelle 6 — Härte in den üblichen Lieferzuständen

Stahlbezeichnung	Kurzkname	Nr.	Härte im Lieferzustand						
			+S HBW max.	+A HBW max.	+U HBW max.	+AC ^{II} HBW max.	+AC ^{II} +C HBW max.	+FP HBW	+A+C HBW max.
Durchhärtende Wälzlagerstähle									
100Cr6	B1	b	—	—	207	241 ^{f, d}	—	—	
100CrMnSi4-4	B2	b	—	—	217	—	—	—	
100CrMnSi8-4	B3	b	—	—	217	251 ^d	—	—	
100CrMnSi8-6	B4	b	—	—	217	251 ^d	—	—	
100CrMo7	B5	b	—	—	217	251 ^d	—	—	
100CrMo7-3	B6	b	—	—	230	—	—	—	
100CrMo7-4	B7	b	—	—	230	260	—	—	
100CrMnMoSi8-4-6	B8	b	—	—	230	—	—	—	
Einsatzhärtende Wälzlagerstähle									
20Cr3	B20	e	207	156 bis 207	170	f	—	—	
20Cr4	B21	e	207	156 bis 207	170	f	140 bis 187	—	
20MnCr4-2	B22	255	207	163 bis 207	170	f	—	—	
17MnCr5	B23	e	207	158 bis 207	170	f	140 bis 187	—	
18MnCr5	B24	255	217	170 bis 217	175	f	152 bis 201	—	
18CrMo4	B25	255	207	166 bis 207	170	f	137 bis 194	—	
20CrMo4	B26	255	207	163 bis 207	170	f	146 bis 193	—	
20MnCrMo4-2	B27	255	207	166 bis 207	170	f	146 bis 193	—	
20MnCrMo5-2	B28	e	212	163 bis 212	170	f	149 bis 194	—	
20NiCrMo7	B29	255	229	174 bis 229	170	f	154 bis 207	—	
18CrNiMo7-6	B30	255	229	179 bis 229	179	f	159 bis 202	—	
18NiCrMo14-6	B31	255	—	—	241	f	—	—	
18NiCrMo16-5	B32	255	—	—	241	f	—	—	
Induktionshärtende Wälzlagerstähle									
C56E2	B40	255 ^f	229	—	—	—	—	—	
S5Mn4	B41	255 ^f	229	—	—	—	—	—	
70Mn4	B42	255 ^f	241	—	—	—	—	—	
43CrMo4	B43	255 ^f	241	—	—	—	—	—	
Nichtrostende Wälzlagerstähle									
X4Cr14	B50	h	—	—	248	f	—	—	
X6Cr14	B51	h	—	—	256	f	—	—	
X16CrMo17	B52	h	—	—	256	f	—	—	
X8CrMoV18-1	B53	h	—	—	256	f	—	—	
Warmharte Wälzlagerstähle									
80MoCrV42-16	B60	h	—	—	248	f	—	—	
13MoCrNi42-16-14	B61	h	269	—	—	—	—	—	
X82WMoCrV8-5-4	B62	h	—	—	248	f	—	—	
X75WCrV18-4-1	B63	h	—	—	268	f	—	—	

^a Für Einsatzstähle wird dieser Zustand verwendet, wenn Kaltumformen vorgesehen ist. Bei durchhärtenden nichtrostenden und warmharten Wälzlagerstählen wird dieser Zustand auch verwendet, wenn der Stahl durch spanendes Bearbeiten weiterverarbeitet wird.

^b Wenn dieser Zustand benötigt wird, sind der Höchstwert der Härte und die Anforderungen an das Gefüge bei der Anfrage und Bestellung zu vereinbaren.

^c Die Härte von Draht für Nadellager darf bis zu 331 HBW betragen. Der Höchstwert der Vickers-Härte (HV) ist bei der Anfrage und Bestellung zu vereinbaren.

^d Die Härte von kaltgetriggerten Holztangen darf bis zu 321 HBW betragen.

^e Unter geeigneten Bedingungen ist diese Sorte im unbearbeiteten Zustand schweißbar.

^f Je nach Kaltumformgrad dürfen die Werte bis zu etwa 50 HBW über denen für den Zustand +AC liegen. Wenn erforderlich, dürfen genaue Anforderungen bei der Anfrage und Bestellung vereinbart werden.

^g Je nach chemischer Zusammensetzung der Schmelze und den Maßen kann Zustand +A erforderlich sein.

^h Schweißbarkeit ist im Allgemeinen nur im Zustand +AC oder im Zustand +A (nur für Sorte 13MoCrNi42-16-14) möglich.

February 2015

DIN EN ISO 683-17	DIN
--------------------------	------------

ICS 77.140.10; 77.140.20 Supersedes
DIN EN ISO 683-17:2000-04

Heat-treated steels, alloy steels and free-cutting steels – Part 17: Ball and roller bearing steels (ISO 683-17:2014); English version EN ISO 683-17:2014, English translation of DIN EN ISO 683-17:2015-02

Für eine Wärmebehandlung bestimmte Stähle, legierte Stähle und Automatenstähle – Teil 17: Wälzlagerstähle (ISO 683-17:2014); Englische Fassung EN ISO 683-17:2014, Englische Übersetzung von DIN EN ISO 683-17:2015-02

Aciers pour traitement thermique, aciers alliés et aciers pour décolletage – Partie 17: Aciers pour roulements (ISO 683-17:2014); Version anglaise EN ISO 683-17:2014, Traduction anglaise de DIN EN ISO 683-17:2015-02

Document comprises 32 pages

Translation by DIN-Sprachendienst.
In case of doubt, the German language original shall be considered authoritative.

No part of this translation may be reproduced without prior permission of DIN (Deutsches Institut für Normung e. V., German Standards Institution, 12275 Berlin, Germany). English price group 14 www.din.de www.bnf.fr

Products

Hardening process

Materials for rolling bearings and rolling bearing parts

Among other things, the standard gives precise information about the designations, order details, chemical analyzes, mechanical properties and purity.

The steels are supplied up to a diameter of 250 mm either as a rod or as a tube. Ring dimensions above 250 mm are usually forged.

The most commonly used steels for the products at Eich Rolle Bearings are the above-cited DIN EN ISO from the group of through-hardening steels, the 100Cr6 or according to the wall thickness respectively adapted alloys for better through hardenability. From the group of case-hardened steels it is the 18CrNiMo7-6 or the 19MnCr5. For stainless parts we use the X46Cr13 or X65Cr14.

For applications in the high temperature range we have proven the qualities X40CrMoV51 or X153CrMoV12. Both steels have very good properties in the high temperature ranges.

For the rolling bearing types of the spring technology, a common spring steel strip, namely 50CrV4 or 51CrV4, which is very well researched, like the 100Cr6, is used. We collaborate on the further development of this steel in close cooperation with our suppliers as well as with renowned material institutes. The shapes and qualities used today are the result of many years of continuous cooperation. For use in the high temperature range, we also use specially rolled hot-work steel (X40CrMoV51). As a rule, we use unalloyed carbon steels for pressure rings, discs, but also cages. Cages that are not made of steel are made of brass or high-strength aluminum.

For all materials used, compliance with the chemical analysis in accordance with standards and, in the case of parts subjected to rolling, also the purity of the primary material is a decisive criterion. All material deliveries are documented by appropriate certificates. Additional tests, such as crack tests, ultrasonic tests or similar can be agreed.

Products

Hardening process

Heat treatment

The excellent material quality is the prerequisite for all subsequent production steps. After the soft machining of the parts, the heat treatment follows. This operation is the one in which properties for the components matched to the particular application can be set.

The classical heat treatment process for bearing rings made of through-hardened steels is the martensitic hardening with subsequent tempering.

The parts are heated to a well-defined temperature, held there for a period of time and then quenched. After quenching, the parts then have the so-called quenching hardness. Quenching takes place in an oil bath or today in special polymer blends. After cooling, the parts are then tempered again

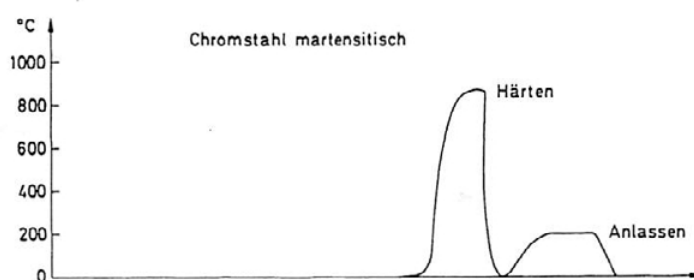

in a corresponding furnace, they are heated again. The tempering temperatures depend on the desired properties, e.g. the temperature resistance. The temperature selected during tempering determines the maximum operating temperature for the part up to which the material has a stable structure. Through the annealing process many variants or properties of chrome steels can be affected, e.g. in a certain temperature window, a disproportionate increase in toughness is achieved with low loss of hardness.

Another well-established method is bainitization (isotemp hardening), which produces a very favorable residual stress distribution in the material. They are achieved by keeping the quenched parts at the material-dependent quenching temperature. Holding for several hours results in a gradual transformation of the microstructure, with residual compressive stresses occurring in the surface layer. These compressive stresses reduce the material fatigue when overstressed and have a reducing effect on cracks, if such form after a high number of load cycles.

Products

Hardening process

Heat treatment

The third hardening process is case hardening. In many applications, rolling element bearings are subject to high impact or flexural fatigue, or due to mounting conditions, the bearing rings have a loose fit. This can lead to relative movements between bearing

parts and on the shaft, with local overheating and cracking as a result. Case hardening steel and the corresponding hardening process are recommended for these applications. After a guided gas carburization, the components are subjected to a martensitic heat treatment, which generates, apart from the hard edge zone around the viscous core, residual compressive stresses in the surface layer.

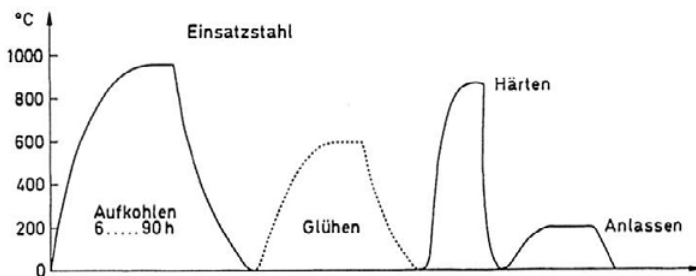
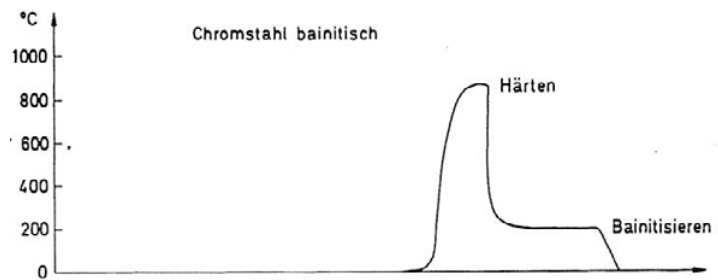

Since case hardening produces a hardness and strength that decreases toward the center of the workpiece cross-section, it is necessary to set case hardening depths

according to load and contact geometry to counteract plastic deformation of the contact point or fatigue damage during static or dynamic operation. The case hardening depth is approximated using the following formula: $E_{ht550HV} \geq (0.07 \dots 0.12) \times \text{rolling element diameter}$. Depths up to approx. 2mm are standard, larger depths are very costly, depending on the size of the component, furnace times of up to 90 hours result.

Products

Hardening process

Heat treatment

Further, the methods of flame or inductive hardening are mentioned. In these methods, only parts of a component can be treated.

In recent years, also some mechanical methods for increasing the component properties have established, namely the shot peening or the solid or smooth rolling. In these methods, near-surface favorable residual stress states are generated.

Last but not least, there are the processes of surface technology - coatings. With these methods, also the properties of the components can be influenced application-related. Here, in particular, the browning and phosphating have become established. By these methods, the run-in behavior and the emergency running properties are increased.

Areas of application

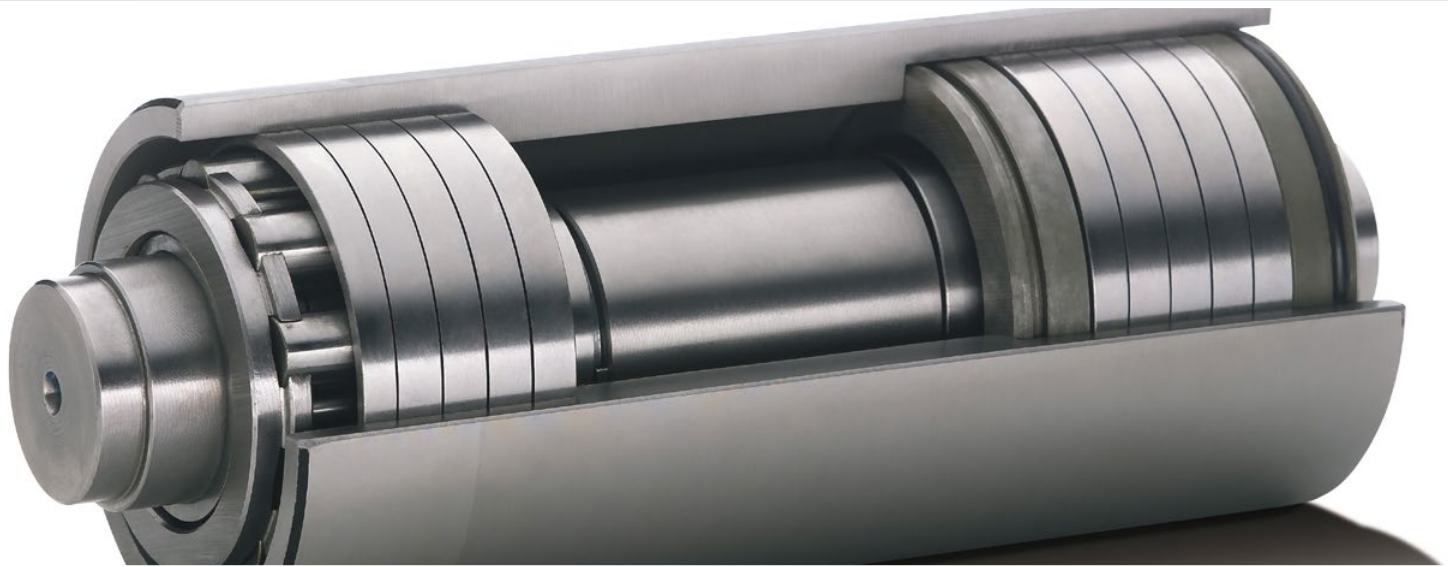

- › Continuous casting
- › Furnace bearing
- › Rolling mills
- › Waste incineratorss

Areas of application

Continuous casting



Areas of application

Continuous casting

Eich Roller Bearings in Continuous Casting - Timeline

In 1968, Mannesmann-Sack at Thyssen Grillo in Gelsenkirchen-Schalke equipped a vertical caster with Eich spring roller bearings. The spring roller bearings impressed with their high resistance against the difficult environment, which was influenced by the negative effect of the secondary cooling and the high temperatures from the casting process.

In addition to these influencing factors, the bearings had to carry load from the ferrostatic pressure. The higher internal temperature in the center compared to the solidified shell leads to an expansion of the strand. This expansion can lead to cracks in the surface, the worsts case is a so called break-out. The solidified shell breaks and liquid steel flows into the machine. Loss of production, plant damage and in the worst-case danger to the life and limb of employees could be the consequences.

View of a plant breakdown strand looking into the „leaked“ strand



Areas of application

Continuous casting

From a single source - bearing solutions from the casters footrollers to the straightening segment

Eich Roller Bearings were well-known for its robustness in roller conveyors at Sack and thus became a standard for continuous casting plants. Since the late sixties, our products have been used in more than 250 continuous casters as original equipment.

Eich Roller Bearing offers bearing solutions for problems when using rolling bearings in plants for the production and forming of steel. Due to decades of cooperation with equipment manufacturers and operators, Eich Roller Bearings has a strong know-how. Numerous steel mills rely on the products of Eich Roller Bearings, which includes bearing solutions for many bearings applications on casters that have hindered continuous production due to premature failure of the bearings. Numerous steel mills around the world benefit from the quality of tailor-made solutions that enable increasing productivity and maximum reliability to be achieved economically and safely. With our current program for continuous casting plants, consisting of ABC bearings, SACRB and split bearings, Eich offers bearing solutions that are perfectly tailored to the requirements of continuous casting plants.



BR bearing

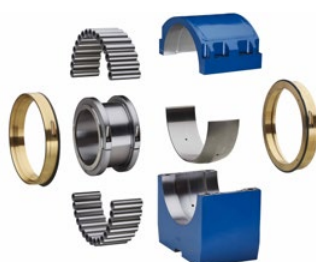

Split bearing



SACRB bearing

Areas of application

Continuous casting

Spring sleeve bearings in the upper strand guide and casters

ABC bearings are the spring bush bearings for the new millennium. After the spring roller bearing was replaced in the 80s more and more by the Eich spring bush bearing type BR, it was apparent at the beginning of the 2000s that the demands of the systems on the bearings in the upper segments continued to increase.

In some CSP plants and classic slab caster plants, more and more twisted bearing cages were found. It was bearing damage that occurred before the end of the usual life cycle of the bearings. In 2005, Eich presented a solution to address the issues described above that were first reported to our representative for Spain by a plant operator in south of Spain.

The solution continued to consist of two conventional spring bushes and side lateral rings, as these parts of the bearing were inconspicuous and a modified roller cage. So far, the cages of the used types, spring roller bearings and spring bush bearings, were manufactured at Eich by a special riveting process. This connection was overstressed by, for example meandering strand movements, when the strand guide rollers ran to the side of the bearing block and were partially decelerated.

As a result, bearing blocks and the faces of the roller shells were damaged and the rivets on bearing cages loosened or twisted the connecting pins with the rivet heads - twisted. The cage could not fulfill its task of guiding the rolling elements during the rolling process.



Areas of application

Continuous casting

The new solution had to mitigate or ideally solve this problem. Eich developed a snap-mechanism, which also gave the cage its internal name „snap cage“, in which it was possible to dispense with riveting and, in the case of lateral pressure, kept the cage rotating.

In this case, the base ring in which the rolling elements are now guided over their entire length, and the cup are connected

by groove and lock principle shaping. Both rings remain against each other capable of rotating, blocking by lateral pressure belonged to the past as well as bearing damage caused by twisted cages.

The new bearing concept is called ABC Bearing or ABC Spring Bush Bearing because it successfully prevented the blockage of the cage during the casting process. ABC means „anti-blocking-cage“. The



problems with twisted cages are no longer encountered in facilities that use ABC bearings. In more and more new plants, these ABC bearings are provided by the leading equipment manufacturers directly in the original equipment - the ABC bearing is in the process of becoming the new standard for successful spring bush bearings in continuous casting plants.

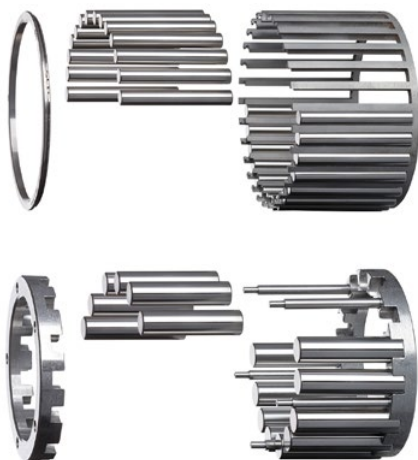

Areas of application

Continuous casting

The concept of „three-ring“ bearings with cross grinding in continuous casting plants

The full complement cylindrical roller bearing has been specially developed for use as a floating bearing in continuous casting plants. Due to the internal design, which optimally fills the cross-section, this rolling bearing achieves an optimum static load capacity.

The SACRB bearing for strand guide rollers as the ideal floating bearing solution allows unconstrained axial displacement and can compensate angular errors >

0.5 °. Due to the full complement design, a maximum static load capacity is possible, which optimally supports the casting strand, especially when the rollers are rotating slowly, even at the main bending points from vertical to horizontal where the greatest forces occur.

The SACRB cylindrical roller bearings by Eich roller bearing receive a special cross-grinding which improves the mobility of the outer ring in the calotte. In the upper segments Eich spring bush bearings are used. Floating bearings in strand guide rollers must balance the longitudinal extent of the waves as casually as possible and compensate for shaft deflection. The high loads require a high static load capacity of the bearings. The common floating bearing solutions usually represent a compromise and do not meet these requirements optimally. The new SACRB three-ring roller bearing (Self-Aligning Cylindrical Roller Bearing) combines the advantages of full complement cylindrical roller bearings with the properties of a toroidal bearing.



Areas of application

Continuous casting

The concept of „three-ring“ bearings with cross grinding in continuous casting plants

High radial load capacity, ease of axial displacement and the ability to compensate for angular errors. All combined in a bearing that does not need to be mounted offset, as in the case of a toroidal bearing, to compensate for the heat expansion of the roller. It can also be easily assembled and disassembled with assembly instructions, films and auxiliary equipment at its disposal. The optimized floating bearing already proves its worth in numerous strand guide rollers. It has been used since 2004 in more and more installations by operators as a substitute for insufficient standard bearings and plant manufacturers in the original equipment of new plants.



Areas of application

Continuous casting

Split bearing units with water cooled housings - split bearings

Ideal bearing solution - low maintenance highest supporting effect

For the installation in driven rollers, there are shared full complement cylindrical roller bearings made by Eich Rollenlager for decades, installed in a housing with included cooling system, also designed by Eich. These fully radially split bearing units complement the range of Eich products for use in continuous casting plants. The operating conditions in continuous casting plants place the highest demands on the bearings used. The bearings are subject to high loads at low speed.

The bearings must work reliably despite high temperatures and thus caused lubricant problems. These split bearing units run as a center bearing to prevent deflection of the roller and accommodate misalignments.

In the down part of the unit a half outer ring, with a special ground spherical surface, ensures the aligning of the bearing in misaligned position. The fact that only a half outer ring is used saves space for the upper part. This space is used for efficient water cooling. The housing is made of steel to offer maximum stability and usually. It can be reused several times, the bearing and the housing can be changed separately and are available as a spare part.

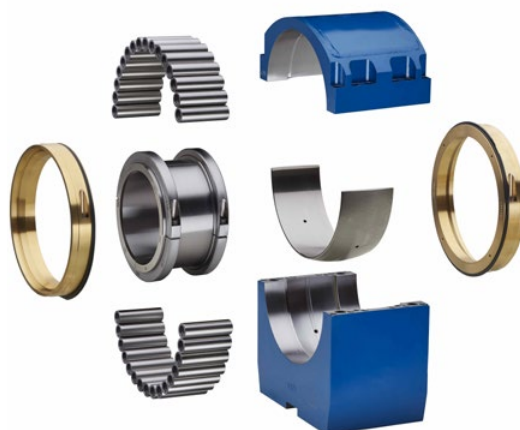

Areas of application

Continuous casting

In the meantime, Eich has also overhauled the housing for customers, which enables the further use of the housing after damage, thus further improving the customers' total cost of ownership (TCO) and life-cycle cost (LCC), similar to the repairable spring-bush bearings.



These bearings also provide a smooth axial displacement and compensation of angular errors and assembly and disassembly without special tools. There are detailed installation videos and instructions for this.

DOWNLOADS ASSEMBLY INSTRUCTIONS

By clicking on the respective button you can open PDFs for viewing and download as needed.

MOUNTING VIDEOS

Areas of application

Furnace roller bearing



Areas of application

Furnace roller bearing

2019

Eich Rollenlager has been a provider of special furnace bearings for 80 years. Eich type B and UL spring roller bearings are a special design of spring bush bearing. They are particularly suitable in applications with high temperatures, frequent unforeseen shocks, misalignments and considerable amount of dirt. An ideal, flexible rolling bearing for extreme environmental conditions.

Advantages of the spring roller bearings are:

- _ Suitability for high operating temperatures
- _ Low sensitivity to dirt
- _ The compact design enables optimized bearing cross-sections
- _ The flexible rolling element made of winded steel has a shock absorbing effect
- _ The modular design of the bearings also makes it possible to replace individual parts during revisions



The current spring roller bearings for furnaces are available as floating bearing type B (free side) and as locating bearing type U (fix side). The floating bearing type B consists of the spring outer sleeve, the spring roller cage, two lateral rings (to guide the cage) and a long flexible inner bush (the length of the inner flexible bush depends usually on the expected thermal expansion). The type U/UL bearing consists of the spring outer sleeve, the spring roller cage, the spring inner sleeve and the inner and outer lateral rings arranged on both sides (these lateral rings fix and guide the bearing). Depending on requirements, the bearing is fixed by the use of hardened lateral rings. The application for spring bush bearings for furnaces are designed as a floating (B type series) and a locating bearing (U/UL type series) bearings.

Areas of application

Furnace roller bearing

The inner and outer rings, the so called spring bushes, are made from specially cold-rolled and form-rolled tempered steel. The spring bushes undergo a 6-stage, constantly evolving manufacturing process. Here, the outstanding properties for the function are set as a robust, fault-tolerant functional part (optimum ratio of strength and ductility). A big advantage for the user is the very simple assembly of the spring bushes. The spring inner bush is made with a defined undersize to the shaft / axis and the spring outer bush accordingly with a defined over size to the inner diameter of the furnace roller, the so-called pre-tension.

This pre-tension ensures the safe fit of the spring bushes on the corresponding bearing seat. Compared to standard bearings, there are no special tolerances or surface qualities to be set for the bearing seat surfaces (cost-effective production of the adjacent construction). Another great advantage of the spring bushes is the high adaptability, e.g. In the case of high temperatures any thermal expansions are easily compensated by the structure of the spring bushes. An important note for the use of spring bushes is the restriction that they must not be axially strained.



Outerspringbush



Innerspringbush

Areas of application

Furnace roller bearing

Spring roller cage

The spring roller cage consists usually from the spring rollers, two cage rings and the double neck pins, these are riveted at their ends to connect the assembly and guide the spring rollers. But the special element is the rolling element, the spring roller, which we will discuss separately. Spring roller cages are usually riveted with a flat head. A special design with a round head is used when it is assumed that the cage receives axial forces or movement against the connected construction. The semicircular heads of riveting then serve as sliding elements with point contact. The spring roller is a hollow rolling element, which explains the lower load capacity compared to a solid rolling element. Under load, the contact surfaces (rolling elements / raceways) show some kind of flexible reacting on loads. The spring rolling ele

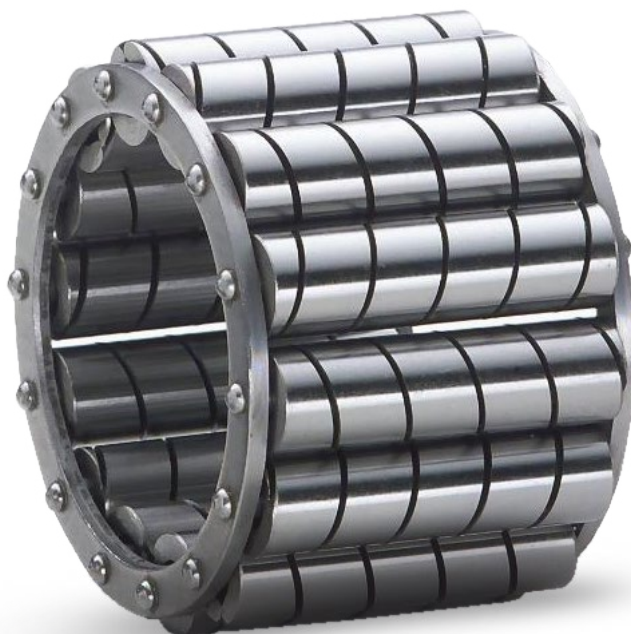

Spring roller cage

Areas of application

Furnace bearing

Cage design für spring roller

The spring roller is a hollow rolling element, which explains the lower load capacity compared to a solid rolling element. Under load, the contact surfaces (rolling elements / raceways) show some kind of flexible reacting on loads. The spring rolling element “deforms” radially as well as axially, it becomes smaller and longer, in other words it stays round and thus rotatable or continuous to “roll”. These properties have been determined in extensive scientific experiments, also to derive from it a corresponding formula work, to establish a method to calculated load ratings and life. The limit of the spring roller is the alternating bending stress, which occurs at the inner diameter of the spring roller. Spring rollers are suitable for a maximum speed of 500 - 1000 revolutions per minute.



Standard FRO

Areas of application

Furnace bearing

Application examples for furnace

Aluminum furnace cars are subject to both high loads and temperatures, as well as increased axial forces. This leads to heavy loads on the installed furnace wheel bearings. Due to the properties of the rolling elements, a spring roller cage safely accommodates the misalignments and temperature effects and reduces downtimes.



Furnace with bearing



Areas of application

Furnace bearing

Application examples for furnaces

In contrast to the furnace car, the spring roller bearings are mounted in tunnel furnaces as loose and fixed bearing by means of bearing flanges on the furnace wall. The bearings work directly in the furnace atmosphere and are partly also under the stress of flue gas. The bearings are subjected to high loads both by the temperatures, as well as shocks in the transfer of goods between the furnace hearth rolls.

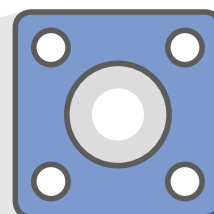
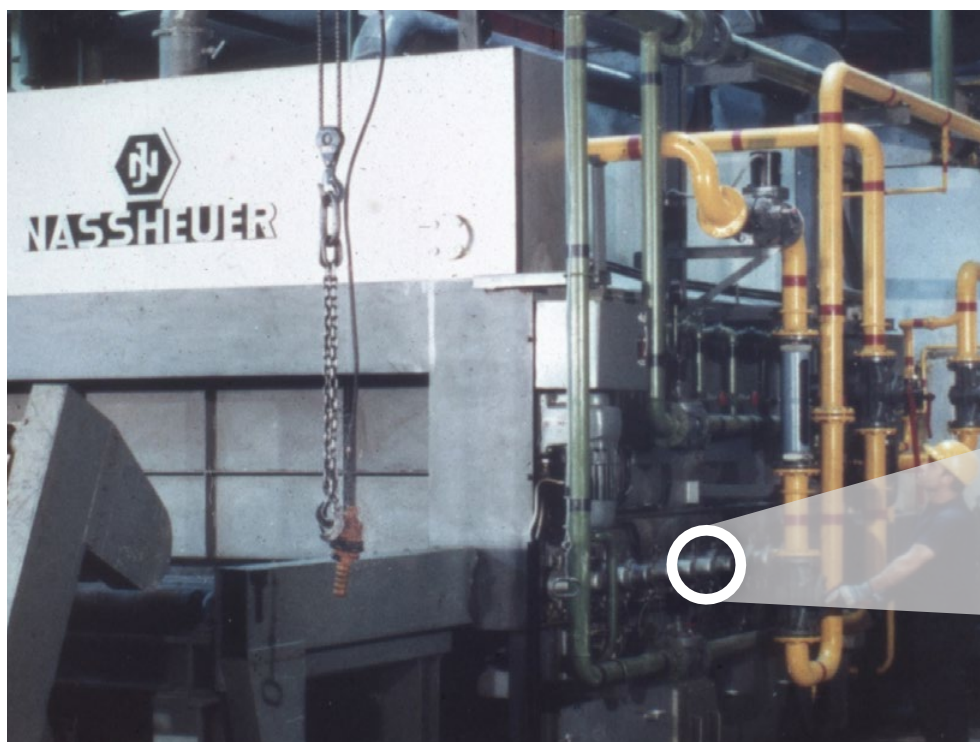

Tunnel furnace with spring roller bearing

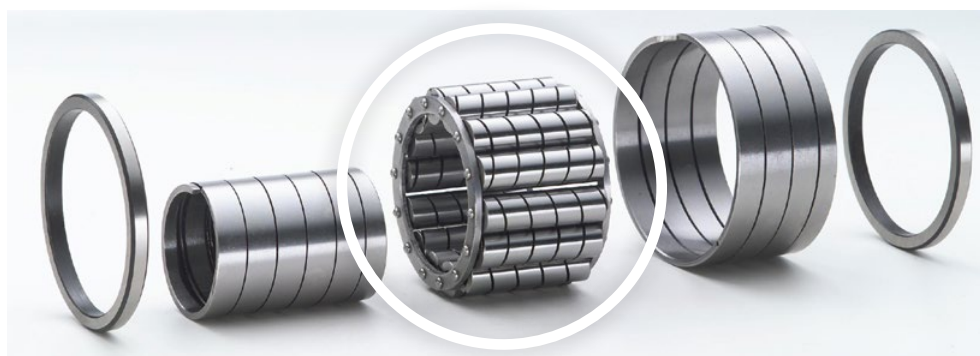

Standard spring roller cage

Areas of application

Furnace bearing



- _ Illustration of a B-type free side bearing with spring rollers consisting of the spring roller cage, spring sleeves and lateral stop rings.
- _ Heat stabilized up to 350 ° C
- _ Common use environments are high temperature applications with heavy impact by the medium being transported.
- _ Particularly resistant to the negative effects that can be caused by high temperatures, impacts, insufficient lubrication, penetrating media (flue gas).
- _ Compared to the standard, such as spherical roller bearings or ball bearings, the spring roller bearing is better suited to absorb impacts, impurities and offers better load ratings at a lower overall height.

Areas of application

Furnace bearing

Already used bearing versions of the B / UL bearing

Product type	Product No.	Product Dimension	Weight [kg]	C0 [kN]
b	558e	30/65 mm x 80/40 mm	0,70	41,00
ul	351e	30/65 mm x 40 mm	0,55	41,00
b	499e	40/75 mm x 120/58 mm	1,08	72,00
ul	375e	40/75 mm x 58 mm	0,97	72,00
ul	033e	40/82 mm x 69 mm	1,50	95,00
b	035e	40/82 mm x 140/69 mm	1,70	95,00
ul	5872e	45/95 mm x 70 mm	2,10	115,00
b	11112e	50/92 mm x 106/69 mm	1,84	110,00
ul	10531e	50/92 mm x 69 mm	1,75	110,00
ul	1171e	55/97 mm x 69 mm	1,85	117,00
b	1170e	55/97 mm x 140/69 mm	1,96	117,00
b	042e	65/102 mm x 140/69 mm	2,16	145,00
ul	4854e	65/102 mm x 69 mm	1,96	145,00
b	2464e	70/120 mm x 140/60 mm	3,14	125,00
ul	7864e	70/107 mm x 69 mm	1,97	165,00
ul	8125e	80/140 mm x 50 mm	3,00	130,00
b	8126e	80/140 mm x 55/50 mm	3,10	130,00
b	2751e	110/170 mm x 100/70 mm	5,39	218,00

Areas of application

Rolling mills

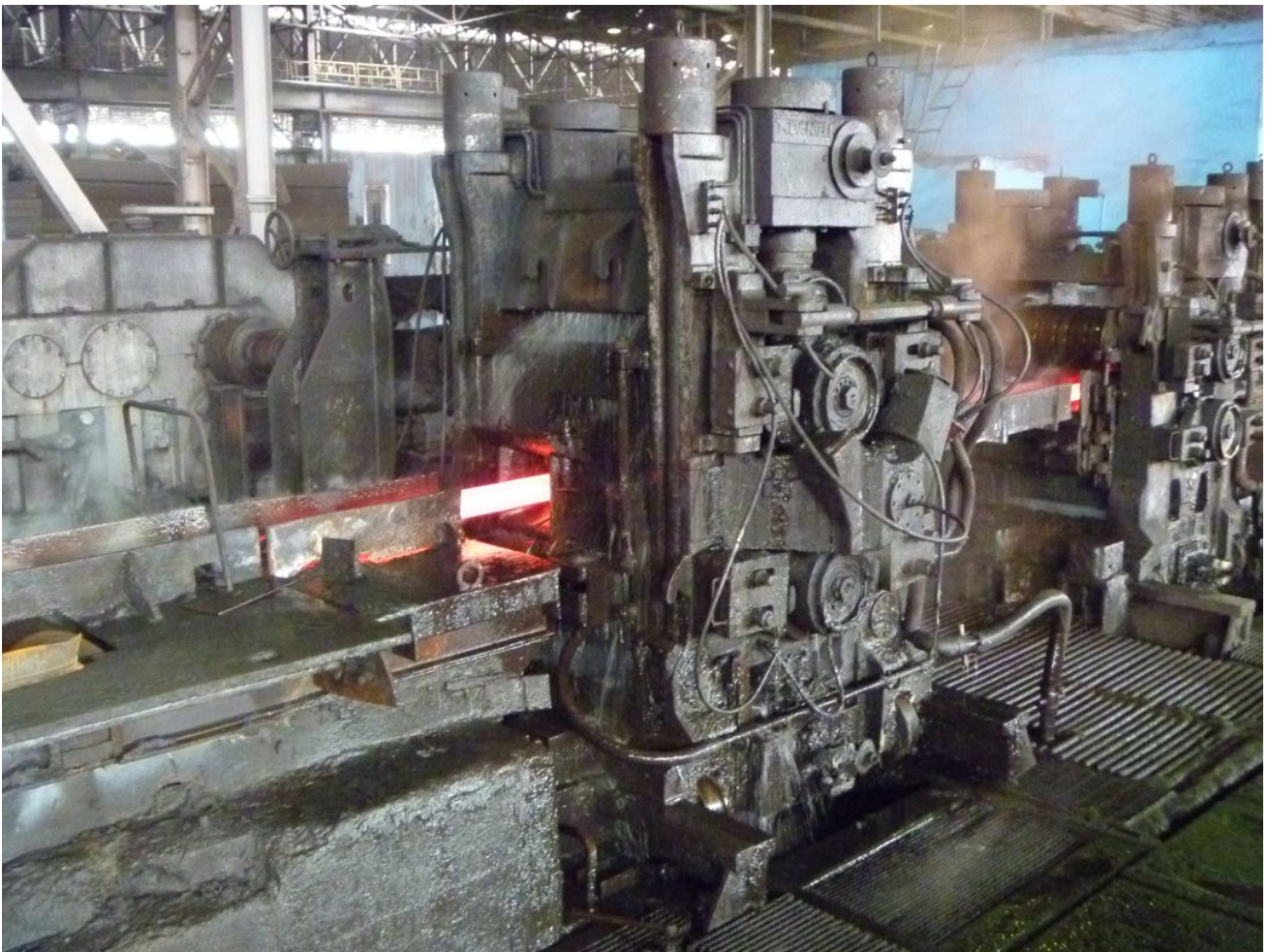

Areas of application

Rolling mills

Eich roller bearings in rolling mill applications

After the spring roller bearings had established itself as a reliable and robust bearing in mining in many places, this bearing design has also been used in steel mills in the nineteen-forties of the last century.

The first place of use was the rollers of roller tables. After the casting of blocks or slabs these are brought to temperature before rolling in so-called walking beam furnace or pusher. The transition from the oven to the roller table is usually a slope over which the material slides on the roller table. A several tons steel block slips on the roller table, which means for the rollers and bearings high impact load, scale and high temperatures. In this application, the Eich spring roller bearing type series B (free side) and U/UL (fixed side) have proven it's excellence.

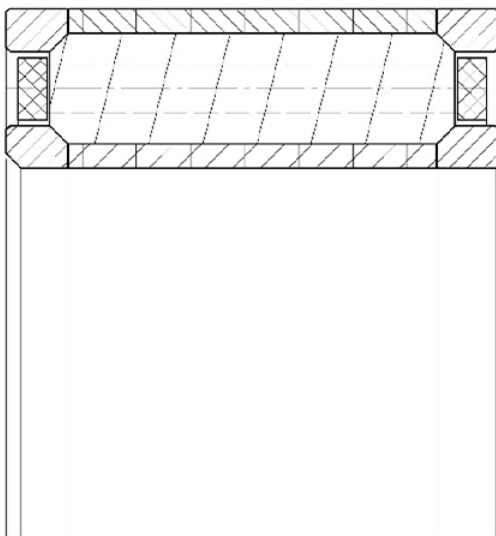

The U spring roller bearing consists of spring inner and spring outer bushes and a spring roller cage with specially wound and shaped rolling elements. This spring roller cage is combined with corresponding pressure rings inside and outside on the fixed bearing side. Occurring axial forces are forwarded by means of the pressure rings on the spring rollers to the adjacent construction.

On the non-locating bearing side (type series B), with straight rolling elements, the thermal expansion is carried out. This possible expansion makes it possible to turn the spring rollers blocklessly.

The spring bearing technology developed by Eich consists of the combination of a cage with flexible rolling elements and wound bearing rings. This method, which has been patented and used successfully worldwide, has brought significant benefits to the life of roller bearings in hot rolling mills.

Areas of application

Rolling mills

Eich roller bearings in rolling mill applications

These bearings can be impacted by high shock loads, are very fault tolerant of misalignments and handle incoming scale particles. As a result, these rolling bearing designs achieve a high life time in comparison with standard rolling bearing bearings, for which high costs for sealing and lubrication must be taken to achieve even a little better lifetimes. Another application is roller tables for so-called long products (billets, beams or tubes). These roller tables are very long and the drive trains are relatively compact.

The drive shafts are very long consequently they must be supported several times over their length, for this application, there are the spring roller bearings as a split bearing to ensure the assembly or a faster replacement of parts during operation. The bearing design is called ELMA (split) and consists of a solid outer ring and a spring roller cage, the spring roller cage runs directly on the drive shaft.

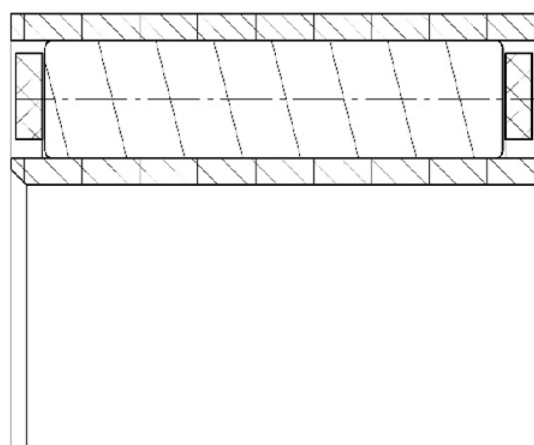

Areas of application

Rolling mills

Eich roller bearings in rolling mill applications

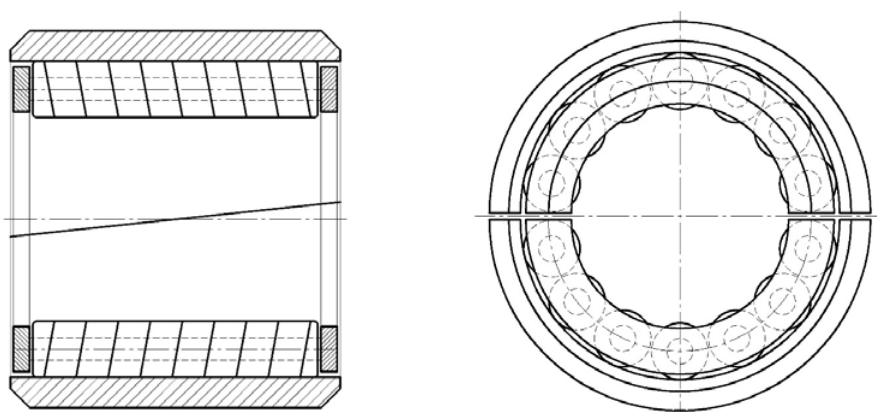

For applications in which the installation space is limited usually the types EL, ELMA and ELR are used all types have no inner ring, i. The roller baskets run on a hardened pin, which can be dispensed with an inner liner.

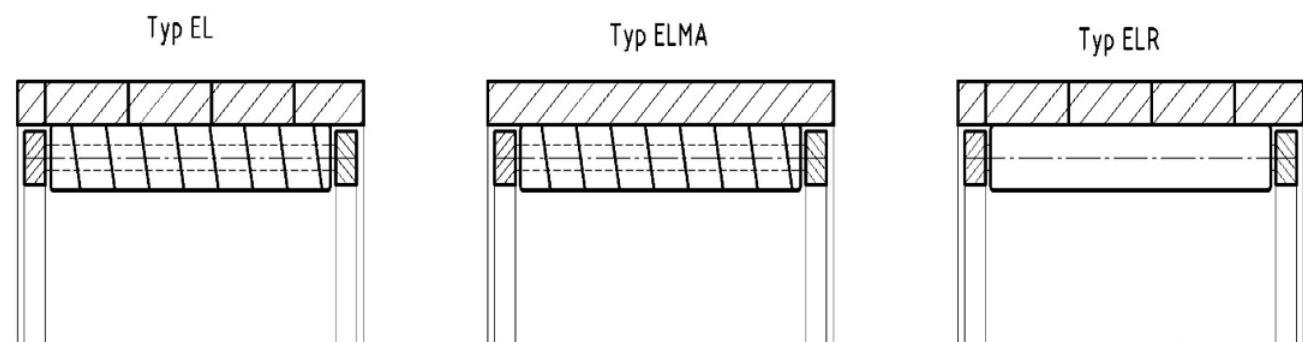

In rolling plants for long products, the rolling stock is guided or steered on entry and exit. This is usually ensured via so-called vertical rollers.

Areas of application

Rolling mills

Eich roller bearings in rolling mill applications

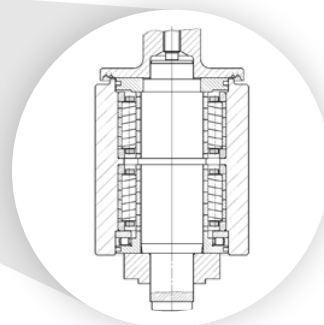

For this application, the spring roller bearing type B or as a ready-to-install vertical roller is suitable.

Areas of application

Rolling mills

Eich roller bearings in rolling mill applications

The Eich spring roller and spring bushing technology is also used in various auxiliary equipment in rolling mills. One example is the transport carts at rolling mill stands. Working and support rollers in rolling stands are removed at regular intervals from the roll stand and reground. When removing these rollers are pulled including the chocks, for transport they are placed on trolleys to transfer into the roll grinding



shop. The settling of the rolls happens with the utmost care, but nevertheless there are always situations in which the parts „fall“ on the car. With unit weights of up to 20 t, corresponding impacts occur.

Eich has developed solutions that are still used successfully today.

These are the types BR and ULR.

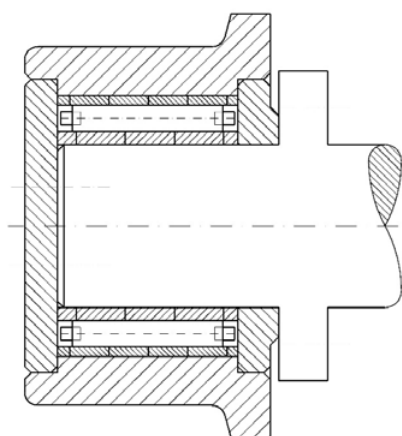

Areas of application

Rolling mills

Eich roller bearings in rolling mill applications

Optimal environmental conditions are required. The radial space in the chock is low. The diameter of the roll neck should be as large as possible with respect to the diameter of the roll barrel. As a result, stress peaks are minimized at the transition from roll neck to roller barrel to a minimum. In a given radial space, the cylindrical roller bearing of all bearing types brings the largest load rating.



Usually, the cylindrical roller bearings used are 4-row, with a variety of cages (steel or brass, comb cage, closed cage or pin-type). The particular design is essentially based on the requirements of the rolling mill.

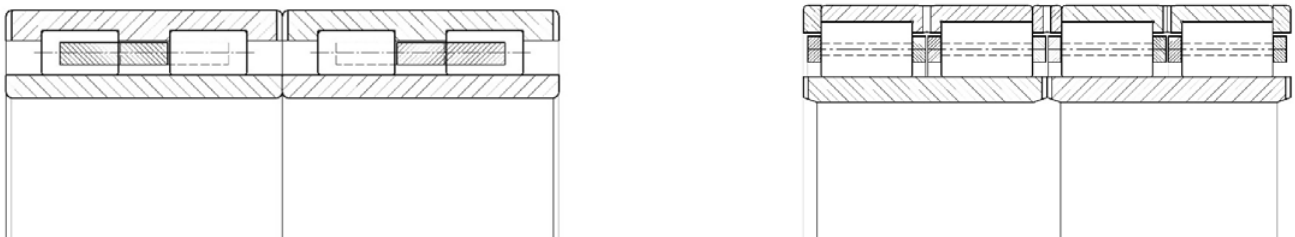

When rolling hot strip, the rolling stock passes through several, usually 4 or 6 roll stands. The individual rolling stands are at a distance. So that the sheet does not sag, it is guided by so-called looper rolls and held on tension. These loopers are hydraulically turned on during operation. For this application, the BMI have proven themselves.

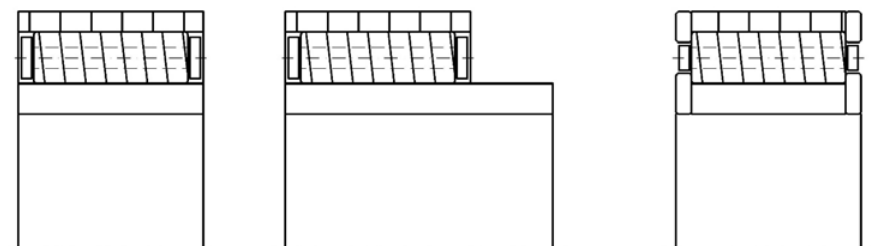

Areas of application

Rolling mills

Eich roller bearings in rolling mill applications

The work rolls of large rolling mills are driven by cardan shafts or joint spindles. After each pass of the rolling stock, the rollers are adjusted in height. The drive shafts must follow this adjustment and therefore are articulated.

So that the deflection angles are not too large, the drive shafts are usually very long. Because of the high torques to be transmitted, they are also designed accordingly strong and heavy. For larger rolling mills, the dead weight of the cardan shafts is supported in split single or double row cylindrical roller bearings to relieve the joints and hits from the weight forces. Changes in position of the cardan shafts are compensated in the housing suspensions.

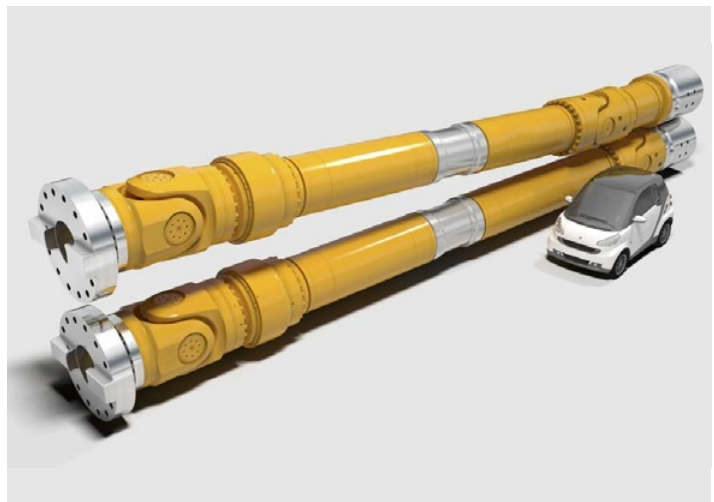

Split Eich bearings for cardan shafts have been used successfully up to bearing internal diameters of 1000 mm. They are available in single-row versions combined with a second bearing. The most common version, called double-bearing. Both bearing versions are installed completely radially split on the PTO shaft. Eich has

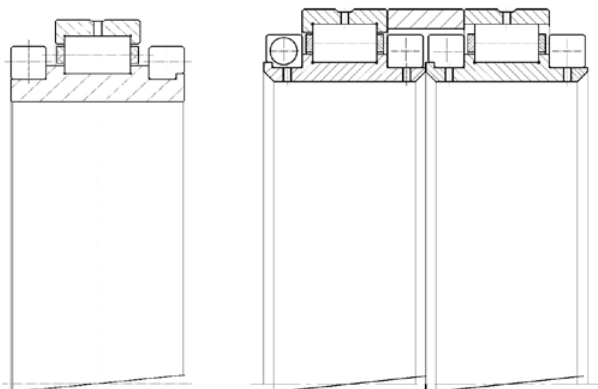

been working successfully with leading rolling mill manufacturers and cardan shaft manufacturers for many years. Eich is u.a. OEM for universal joints of well-known European manufacturers. Eich products ensure that PTO shafts in rolling and upsetting applications are safe to operate.

Areas of application

Rolling mills

Eich roller bearings in rolling mill applications

Another area of application for Eich roller bearings is the transport area in rolling mills. After the rolling process, the finished product is wound up, it is coiled. These coils are brought to the finished product

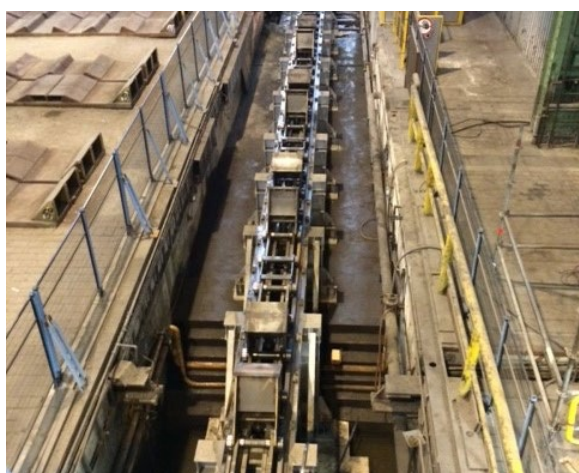

store for cooling and storage. The coil weight is up to 45 [t]. They are transported by heavy conveyor chains, which can be several hundred meters long. In transport chains of this kind, are usually full-complement bearings used as rollers, safely transport the high coil weights over rail track.

By full complement rollers of the company Eich will ensure that maximum load capacity is combined with the robustness of our products. Due to dirt and scale in areas of the rails and chains often a combination of high weight with high temperatures and some coarse dirt has a negative effect on the life of the roller bearings.

Also, the outer shells of the rollers often have to roll on the rails over scale, which falls off the rolled strip. The full complement support rollers provide the maximum load rating, while the roller outer ring keeps its elasticity through special procedures to prevent it from over rolling any tender pieces and other parts that are on the rail.

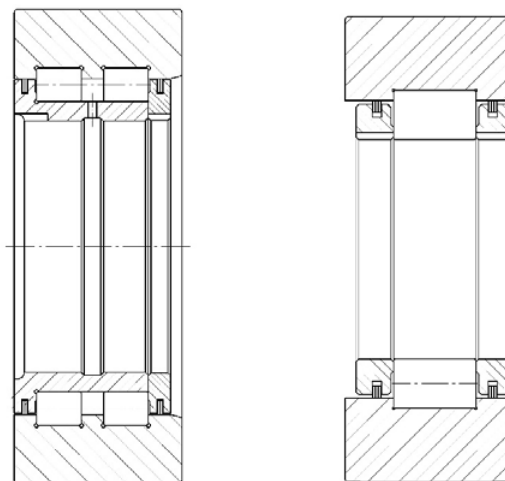

Areas of application

Rolling mills

Eich roller bearings in rolling mill applications

Our bearings are used successfully by European chain manufacturers and rolling mill operators worldwide. Eich also supplies support rollers for circulating chains for rolling mills, which supply rolled strip trim-ming shears. Rolled strip is laterally straightened with these systems. When feeding the sheet, circulating chains are exposed to high axial loads if the alignment is not optimal.

Even in the case of a German steelmaker, the chain was subjected to high axial loads and rotational speeds, and the customer complained that the support rollers used by another manufacturer were failing too quickly. Eich has developed a solution in which a different hardening process was used and the cage principle of the original bearing was changed. The bearing has been optimized in steps and is now used successfully for several years at the customer site. A newly acquired circulation chain was equipped with the corresponding products of Eich roller bearings directly from the chain manufacturer.

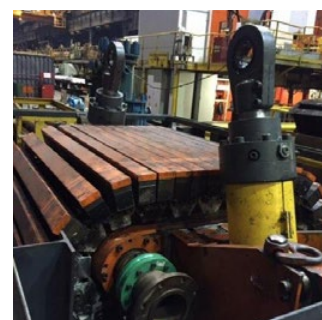

Areas of application

Rolling mills

Eich roller bearings in rolling mill applications

In cold rolling mills, the greatest emphasis is placed on precision in all parts. The products are finished here. The slightest damage on the surfaces means that customers who demand the highest quality would refuse to accept individual coils or even entire deliveries. Multi-row rolling mill bearings are used, which support the work roll in the rolling process as a support bearing.

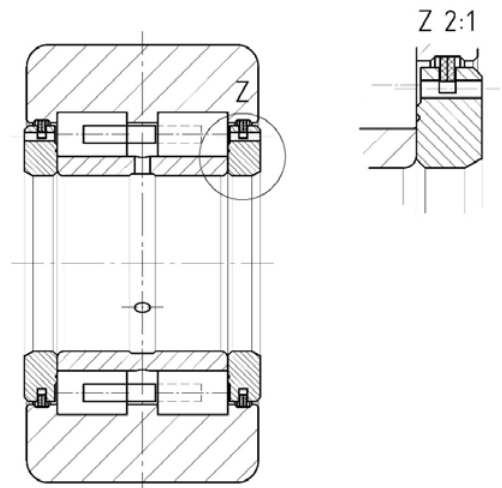
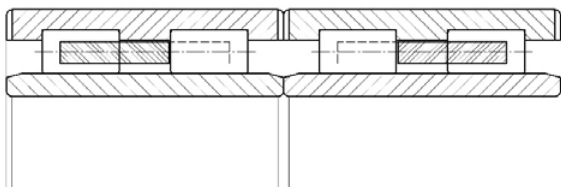

For 20 years now, we have been supplying these systems with bearing inner rings as spare parts, as they wear out faster in the process than the outer ring roller assemblies. Since more than 15 years

we supply the outer ring roller assembly is also part of our supply. Cold rolling is majorly different to hot rolling, the tolerance scope is the most challenging task. The tolerances for the bearings here move in the highest precision classes P5 or P6. By expanding the manufacturing know-how and the machinery, Eich meanwhile gained a status that international customers regularly purchase these products as spare parts for the maintenance of their CVC cold rolling mills.



Areas of application

Rolling mills

Cooling beds

Cooling beds have the task of cooling rolled material from the rolling temperature to approximately room temperature. The difficulties of the cooling process arise from the fact that the material cools differently at the support points than at the free surface. As a result, it can bend between the support points due to the free length. At the same time, the free surface should be as large as possible in order to favor the heat transfer to the surrounding air. The endeavor, despite these difficulties to obtain a distortion-free rolling, led to the development of modern reversible cooling beds. In these, the rolling stock is turned around the longitudinal axis at short intervals.

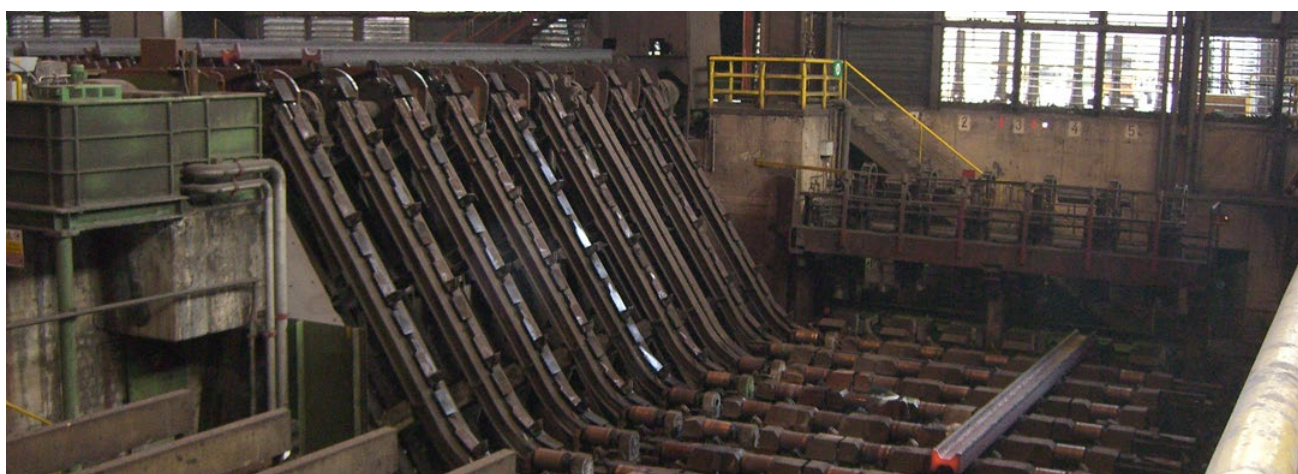

A case of application are, for example, drive shaft and eccentric roller bearing a cooling bed. A crank mechanism moves the conveyor rakes in opposite directions in the horizontal direction. At the same time, eccentric rollers lift up the rakes in the conveying direction with the rolling stock. At the end of the horizontal stroke, the rakes lower and transfer the rolling stock to the next rake. These perform the same movement while the other rakes run back in a lowered position.

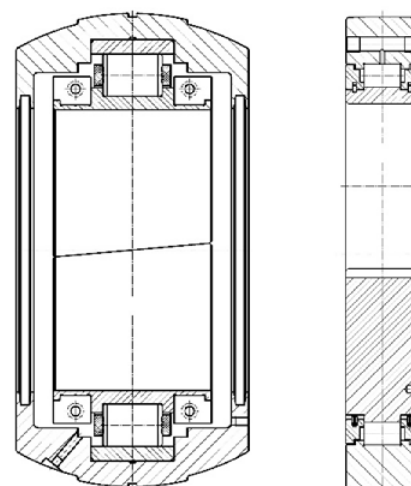

Areas of application

Rolling mills

Levelers

In straightening machines sheets or profiles are straightened by repeatedly bending back and forth in a continuous process straight. The deformation must be so strong that a substantial part of the material cross-section comes into the plastic area. In sheet metal, the forces required for bending are applied by smooth rolls, in profiles by calibrated rollers. In both cases, large radial loads must be absorbed by the bearings at small center distances.



One example is the main bearing of a caliber roll in a heavy profile roller straightener. A double-row, full complement cylindrical roller bearing at this point guarantees a long service life due to its high load rating. The axial displacement takes place in the bearing.

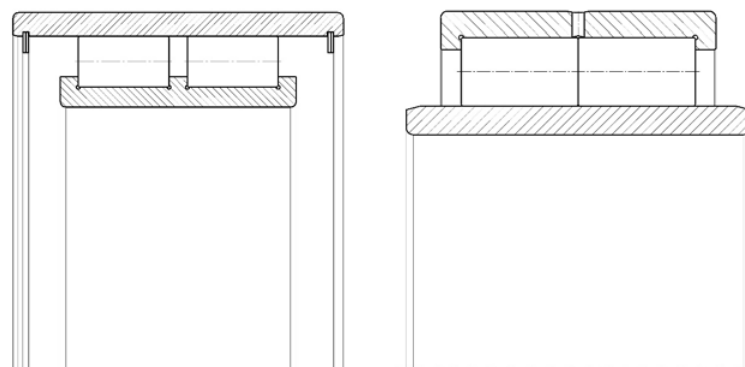

Areas of application

Rolling mills

Levelers

Support rollers in plate treatment plants and stretch-bend-leveling machines for plate are rolling bearings with a thick outer ring, the roller shell. This design is not installed in a bore but is supported on or off a track. In a straightening machine, the long leveling rolls are supported several times over their entire length.



In stretch bend straightening, metal straps under tension are plastically elongated and straightened by continuous reciprocal bending. This achieves excellent flatness of the metal strips.

In contrast to the stretch straightening by pure tension, the deformation of the sheet is created by superimposed tensile and bending stresses in the stretch bending. The sheet is guided over at least two bending rollers, which is followed by a straightening roller. For the deformation of the sheet, the actual radius of curvature is crucial. This is determined by the ratio of sheet thickness to roll radius, the tension, the theoretical wrap angle, the material strength and the modulus of elasticity. In addition, the speed has a certain influence. Decisive for the degree of stretching is the smallest radius of curvature of the band. Under otherwise given conditions, a certain minimum radius of curvature is established for each strip tension, which corresponds in the limiting case to the radius of the work roll.

Areas of application

Rolling mills

Straighteners

The work roll, or its diameter, thus has a great influence on the process. The sometimes also known as straightening rollers work rolls can be installed as a plurality of adjacent work rolls or, as is the case with modern constructions, as a set of straightening rollers. In principle, work rolls with a very small diameter are used. This requires that the work rolls must be reliably supported by appropriate support rollers over the entire length of the roll.

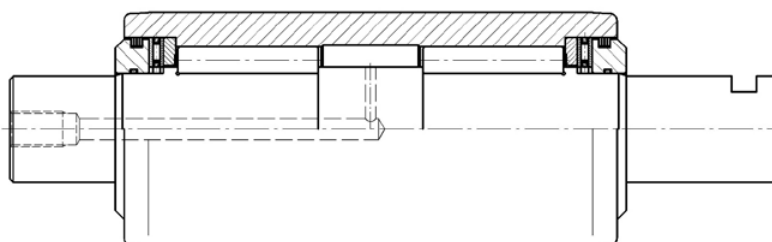

To make matters worse, in certain applications, these rollers must run in a heavily polluted environment (e.g., tinder accumulation). Other rollers (e.g., aluminum stretch bend equipment) require very light running and reliable sealing against leakage of lubricant. The outer rings of the rollers can be reground several times. This is especially important when processing sheet metal with high quality surface finish.

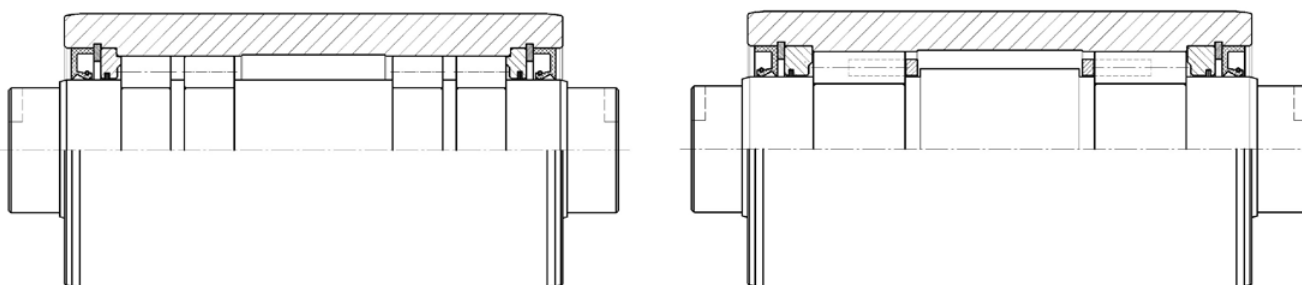

Areas of application

Rolling mills

Straighteners

Rolling bearings for finishing equipment, such as sheet metal cutting machines. In scissors predominantly full complement, multi-row cylindrical roller bearings are installed. Depending on the available installation space, the bearings are 3-, 4-, 5- or 6-row. This design is installed both on the loose and on the fixed bearing side. The low radial height of the bearings, a high static load capacity and a large radial stiffness plays an essential role in applications in scissors. Accordingly, these



bearings are designed for optimal static load capacity. As a rule, the operating loads are not so high, but it always comes back to high shock loads. The design for the optimum static load capacity prevents impermissible plastic deformation at the contact points between the raceways and rolling elements. The rigidity of the bearings is necessary with scissors for an exact positioning of the cutting edges to each other. Multi-row full complement cylindrical roller bearings offer optimum rigidity, static load rating and safety.

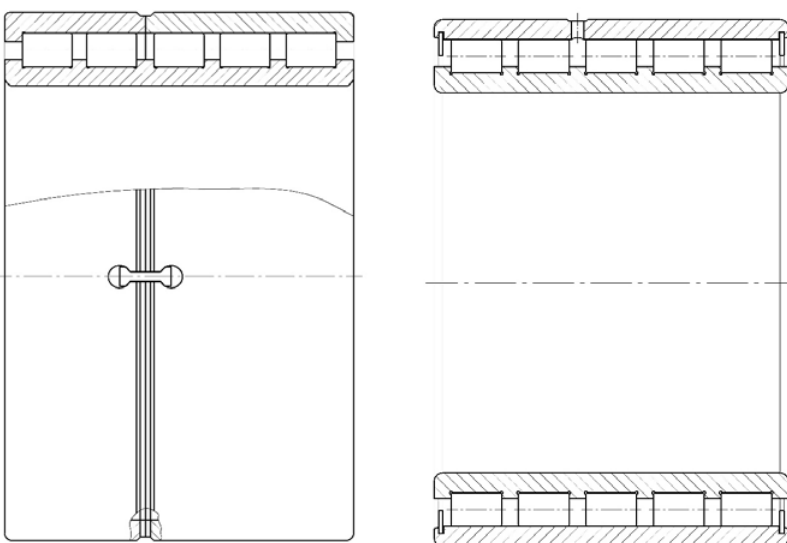

One application is the storage of the cutterhead double trimming shear for heavy plates. For the cut, the cutterhead driven by the plunger pivots at a certain angle to the drum axis.

Areas of application

Waste incinerators

Day after day, enormous quantities of household waste and commercial waste are created, so that the available storage space is no longer sufficient. Recycling or composting provide only a slight relief. Waste incinerators are the suitable solution here!

Waste incinerators have been designed and built by European plant manufacturers since the late 1960s. Many of these plant manufacturers rely on Eich roller bearing products for the storage of various combustion grate systems. Walking and feed grates of other plant manufacturers from Europe were equipped with bearings from Eich Rollenlager. The first roller grates had grate widths of about 2m width and were supplied by the Düsseldorfer Vereinigte Kesselwerke (later developed by Babcock Oberhausen up to 8m grate width).

Since 2005, in Germany and from 2009 Europe-wide landfill sites have not been closed from the then valid standards have been closed. Only landfills constructed or converted using state-of-the-art technology may still be operated to serve as repositories for incineration residues. Biodegradable waste constitutes landfill gas, which consists of about half of the highly climate-relevant methane. The pre-treatment takes place, for example, by incineration with energy recovery in Waste incinerators.



Areas of application

Waste incinerators

This is to convert it into district heating or electricity the heart of such a system is the combustion chamber. Various rust systems are used. For example, roller grates, feed grates or traveling grates. The garbage dimensions developed in the burning or incandescent state, a temperature of 800-1000 ° C, this is needed to avoid the formation of harmful substances such as dioxins. In order to achieve this continuously and ensure sustainable

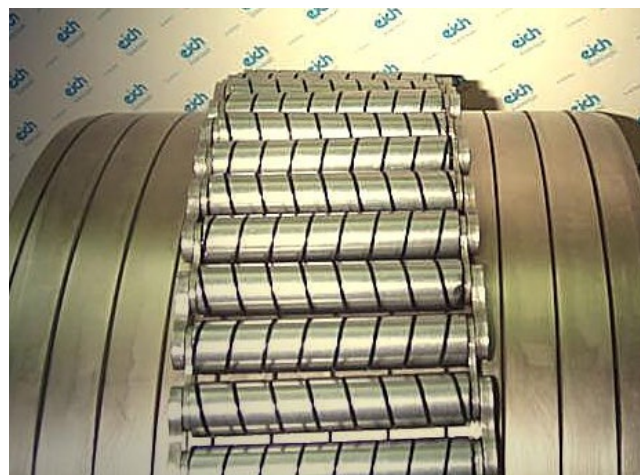

combustion, the waste measures must be constantly moved and ventilated by hot air. This is achieved in roller grates, by rotating the rollers, which have a diameter of 1.5 m and are arranged in a gradient of about 5 m from the first roller to the sixth roller. As a result, the waste is transported from one roller to the next, dried and burned. These rollers are mounted with spring technology Eich rolling bearings, the running surfaces for the spring rollers are spring inner bushes which are mounted on the shaft journal and spring outer bushes which are mounted in a bearing housing. Like the spring bushes, spring rollers are made of spring steel.

The steel used has a considerably higher tempering temperature compared to a conventional bearing steel. The spring roller chain has the function of a bearing cage, which allows a faster assembly due to

its design, because the chains are not closed. The chain is placed around the spring trough or in the spring outer sleeve. The link plates are riveted to the webs, on which spring rollers are inserted.

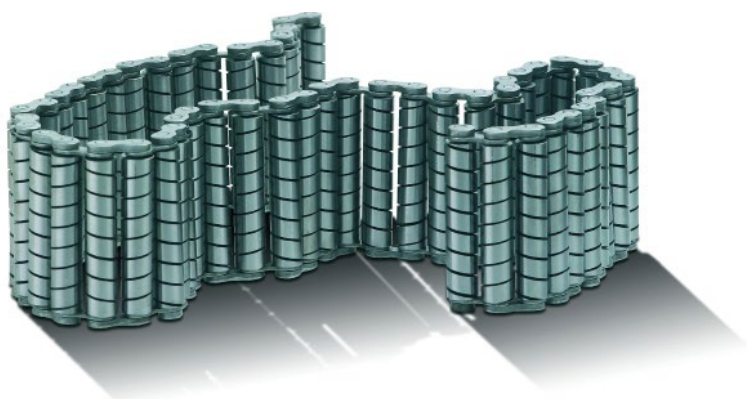

Areas of application

Waste incinerators

The webs and the tabs guide the rolling elements. They are suitable for high temperatures and can absorb elastic edge pressure, which is caused by the bending of the temperature at the top of the roller grate. By Eich roller bearings thus robust and adapted to the particular circumstances bearings were designed for these applications. These bearings have proven themselves outstanding for many years.

The feed grates require support below the grates. This support form the running / support rollers, so that a forward and backward movement of the grates is possible to transport the garbage. These support rollers are also exposed to high temperatures and high pollution by combustion residues at the same time high stress.



These rollers are difficult to access for maintenance and emergency repairs. The grates make only short strokes in operation. A main goal is thus to match the role, axle diameter, roller width, outer contour of the roller race, roller shell hardness, bearing clearance and sealing on each other. The decades of experience in Eich Rollenlager with these applications, which also came from experience in other applications such as storage for furnace construction or for continuous casting plants, have led to good results in cooperation with the customers.

Areas of application

Waste incinerators

Here, the flexibility of Eich has proven itself, because it is always able to provide short-term and unconventional special solutions, which also include bearing housings and bearings in split or undivided design, as well as the complete housing. It can be offered bearing solution for the high temperature range up to 650 °.



In split form, a bearing was designed for the area of the air supply, which allows high speeds and yet can be changed quickly.

The first split ball bearing of Eich Roller Bearing for Incinerators. (see picture on the left)



Also, the removal of the ash on the wet press piston ash is solved with calibration products. In this case, Eich spring bushes are delivered with bolts and as plain bearings lead the forward and backward movement of the pistons.

Service

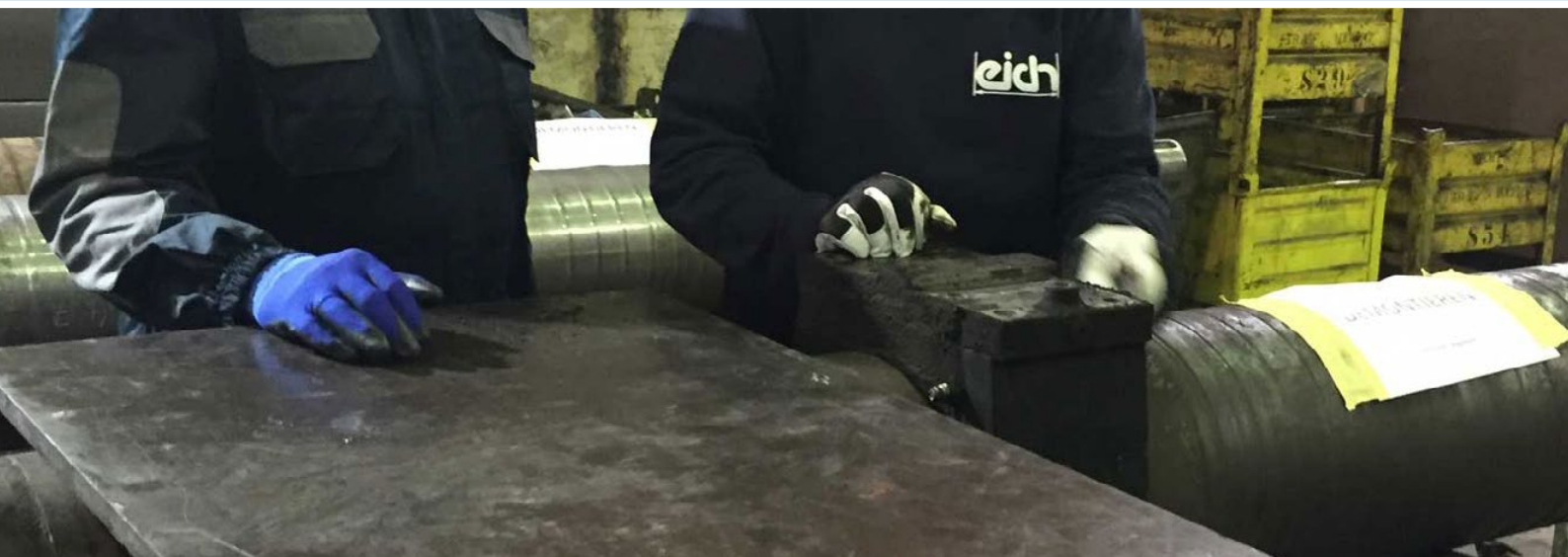

- › Check and repair
- › Spare Parts

Service

Check and repair

Not only in the production of special bearings, we are the right contact for you. The assessment of used bearings and the repair of minor damage are also part of our portfolio. A slight damage of an item or traces of use do not necessarily mean that in many applications complete stock needs to be replaced.

Through our modular system, the exchange or processing of individual parts can extend the life of the spring roller bearing. Proper assessment of used parts can therefore save costs. We are happy to take over the assessment for you. If a revision of the parts is possible and useful, we will do it for you. If a revision is not advisable or not possible, we will make you an offer about the required parts.



In order to make it easier for our customers to assess used parts, we have compiled an overview of whether bearings can continue to be used without hesitation.

The overview is available at the following link:

The replacement of cylindrical roller bearings with an inner or outer diameter of 300mm to 1800mm is usually very expensive. Again, we ask our assessment and repair service. In this type of bearings, an exchange of parts may be possible, but we can edit and reprocess items. This allows our customers to avoid the high cost associated with replacing entire bearings.

Service

Spare parts

Customer service is very important to us at Eich Roller Bearings. For decades, we have been offering our customers a comprehensive repair service. We also do a thorough damage analysis and have a wide range of spare parts. Thanks to the modular system of the spring roller bearings, we have been offering such replacement parts since the early days of Eich. Our clients include companies that have been working with us since the 1970s and benefit from our service. If the bearings or individual parts wear out, they are quickly and efficiently replaced so that the entire bearing does not have to be replaced completely. As a result, many companies not any longer order complete units to Eich, but spare parts for these units. Only the replacement of the individual components by wear then becomes necessary.



Arrival Status

Used housings are waiting for shipping to Eich Roller Bearings.



Housing revision

Intermediate step: used housing during revision by Eich roller bearing.



Housing painted after overhaul

Used housing during revision by Eich roller bearing.

YOU NEED SPARE PARTS FOR YOUR BEARING?

Then feel free to contact us. In addition to the sale of complete bearing units, we offer the purchase of parts as spare parts for our products. The modular system of spring- bushing-bearings enables the extension of service life through the targeted use of spare parts while providing a cost-effective alternative to replacing complete units.

>> CONTACT US <<

Thanks for your interest.

The spring roller bearings listed in this brochure represent only a selection of the possible dimensions and designs.

As a manufacturer of special rolling bearings, Eich can design and offer almost any desired variant for your specific application in the usual dimensions.

Contact details

Eich Rollenlager GmbH

Weg zum Wasserwerk 16

45525 Hattingen

Germany

Phone: +49 (0) 2324 / 5007 - 0

Fax: +49 (0) 2324 / 5007 - 29

Email: **info@eich-rollenlager.de**

Internet: **www.eich-rollenlager.de/en**
